

6x3 GARDEN SAVER WITH METAL ROOF ASSEMBLY MANUAL

Version #1.1
May 3, 2023

Stock Code:
GS63-TG-METAL

Thank you for purchasing a 6x3 Garden Saver. Please take the time to identify all the parts prior to assembly.



Important Information:

- It is the sole responsibility of the customer to check with your local municipal or county by-laws before ordering this product to confirm it complies with building codes in your area.
- If the product is elevated, any structural and building code requirements are solely the customer's responsibility, and should be abided by.
- Snow load ratings vary by geographical location. If heavy or wet snowfall occurs, it is advisable to sweep snow off roof frequently.
- In areas with high or gusty wind conditions, it is advisable to install the structure securely to the ground.
- Have a regular maintenance plan to ensure screws, doors, windows and parts are tightly affixed.
- All structures purchased from Outdoor Living Today are covered for a period of one year for defects in manufacturing and workmanship. Costs incurred for customer installations are not included.
- Failure to use supplied parts included in this kit could result in poor product performance and may void your warranty. Please contact Outdoor Living Today's Customer Toll Free Line if you plan to deviate from our written instructions.

Customer agrees to hold Outdoor Living Today and any Authorized Dealers free of any liability for improper installation, maintenance and repair.

In the event of a missing or broken piece, simply call the Outdoor Living Today Customer Support Line @ 1-888-658-1658 within 30 days of the delivery of your purchase. It is our commitment to you to courier replacement parts, free of charge, within 10 business days of this notification. Replacement parts will not be provided free of charge after the 30 day grace period.

What to do before my Shed arrives?



- Become familiar with this assembly manual and determine if you can complete the project yourself or will require a professional contractor.



- One helper is recommended to assist in constructing your chalet. It generally takes two people less than a day to assemble a chalet. If you're hiring a contractor, their rate should be in line with that duration of work.



- Clear the construction area and ensure a clear pathway for delivery when the freight company arrives. Remove all debris: roots, grass, rocks, etc.



- Excavate the site. Contact your local utilities company to ensure there are no gas or electric lines buried in the area before digging.

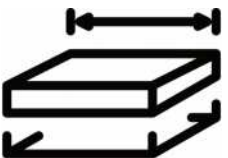

- Decide on the type of foundation you will be using:
 - Concrete slab, or
 - 4-6 inches of crushed gravel with paver stones or 4x4 stringers.

You can find the footprint for your shed on Page 3 of your Assembly Manual.



- If doing the assembly yourself, have all the necessary tools ready to go and in working condition. A list of required tools can be found after the parts list.

Foundation Types for 6x3 Garden Shed

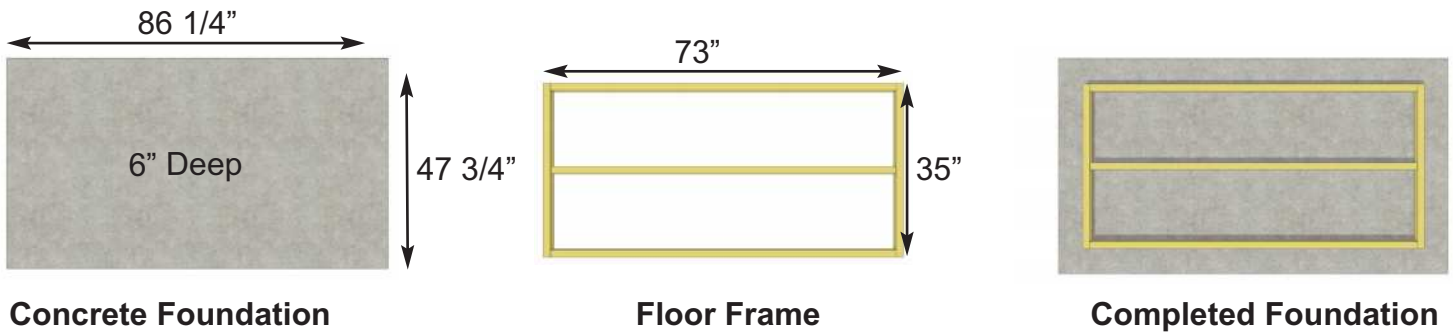

Concrete Foundation

Floor Frame

Completed Foundation

Concrete Slab Foundation:

- Slab must be at least the same size as assembled floor frame (35" x 73") or larger.
- 6" Deep foundation.
- 0.6 Cubic Yards of concrete required.
- A concrete slab will have the longest durability out of your foundation options.

Once level, a concrete slab is the easiest surface to build on.

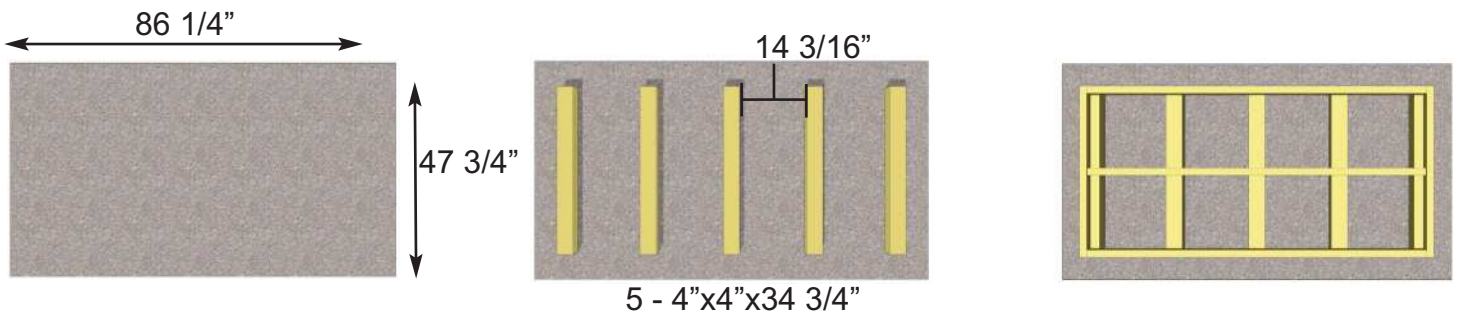

Gravel Foundation

Gravel Foundation with treated stringers

Completed Foundation

Gravel with 4x4 Pressure Treated Stringers:

- Excavate at least 6" deep, and 6" wider than floor frame on each side.
- 0.6 Cubic Yards of gravel required, approximately 6 wheelbarrows.
- 5 - 4x4 Pressure Treated Stringers 34 3/4" long required.
- Evenly spaced, with one at each end of floor frame.

Saves money on materials, easy to level and work with.



Gravel Foundation

Gravel Foundation with Patio Pavers

Completed Foundation

Gravel with Patio Paver Stones:

- Excavate at least 6" deep, and 6" wider than floor frame on each side.
- 0.6 Cubic Yards of gravel required, approximately 6 wheelbarrows.
- 8 patio pavers (8" x 8" or larger).
- Center patio paver stones underneath floor runners and underneath seams in floor joists.

Patio paver stones are widely available from most landscape stores.

6x3 GARDEN SAVER - METAL ROOF

Hardware Kit (Provided)

2 1/2"  100 pcs

2"  14 pcs
Black Headed Screw

1 1/4"  45 pcs

1"  7 pcs

3/4"  5 pcs
Silver

3/4"  24 pcs
Black Headed Screw

1 1/2"  195 pcs
Finishing

1 1/2"  4 pcs
Black Headed Bolt with Silver Nut and Washer

 1 pc
Square Drive Bit

1/4"x 2"  14 Pcs
Metal Roof Screw

 1 pc
1/4" Nut Driver



T Hinge
x 4 pcs



Door
Handle
x 2 pcs



Drop Latch



Silver
Barrel Bolt



1/2 "x 2 1/2" x 2 1/2"
Plywood Spacer

Tools Required (Not Provided)



Hammer



Screw Gun/Drill



Tape Measure



Wood Clamp



3/8" Wrench



Level



Pliers



Ladder



1/8" & 3/8" Drill Bits

Safety Equipment Required (Not Provided)



Safety Glasses



Work Gloves

Regular Maintenance & Tips to prolong the life of your shed.

Before/During Assembly:

- 1.) Paint each face and edge of your plywood floor with a latex exterior paint.
- 2.) Caulk wall seams if gaps appear.
- 3.) Caulk around window framing.
- 4.) Caulk perimeter between floor plywood and bottom wall plate.
- 5.) Caulk channels in lap siding at the top of your door above the trim, just a drop in each channel.
- 6.) Caulk edge of door threshold.
- 7.) Optional: Install a Sill Gasket between floor runners and foundation.
- 8.) Optional: Install an 8" strip of roofing paper below Cedar Ridge Caps for Cedar Roof Sheds.

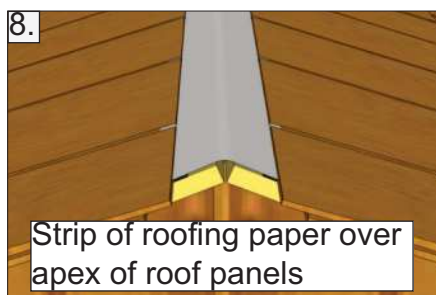
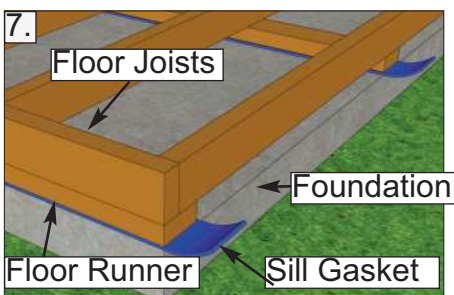
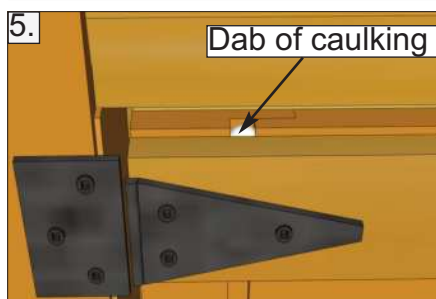
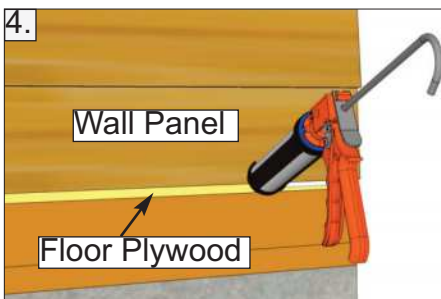
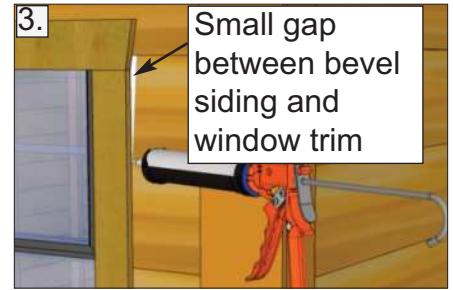
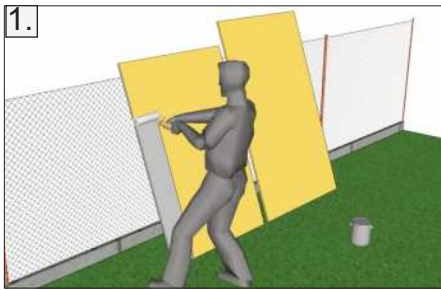

Routine Maintenance:

- Routinely check all fasteners are tight (ex. Door Hinges, Nails)
- Brush off dirt from walls.
- Brush off snow from roof regularly.
- Routinely remove needles and leaves from Metal Roof.

Painting/Staining

- Your cedar shed, if left untreated, will weather to a silvery grey colour.
- Painting or staining your structure is highly recommended and will prolong the life of your shed.
- You do not need to wait to paint or stain your shed, the wood in your kit has been dried and can be stained or painted immediately.
- Consult your local paint store for the best paint or stain for cedar.
- Optional: stain the inside of your shed. (Note: this will remove the fresh cedar smell.)

A. Floor Section

Exploded view of all parts necessary to complete the Wall Section. Identify all parts prior to starting.

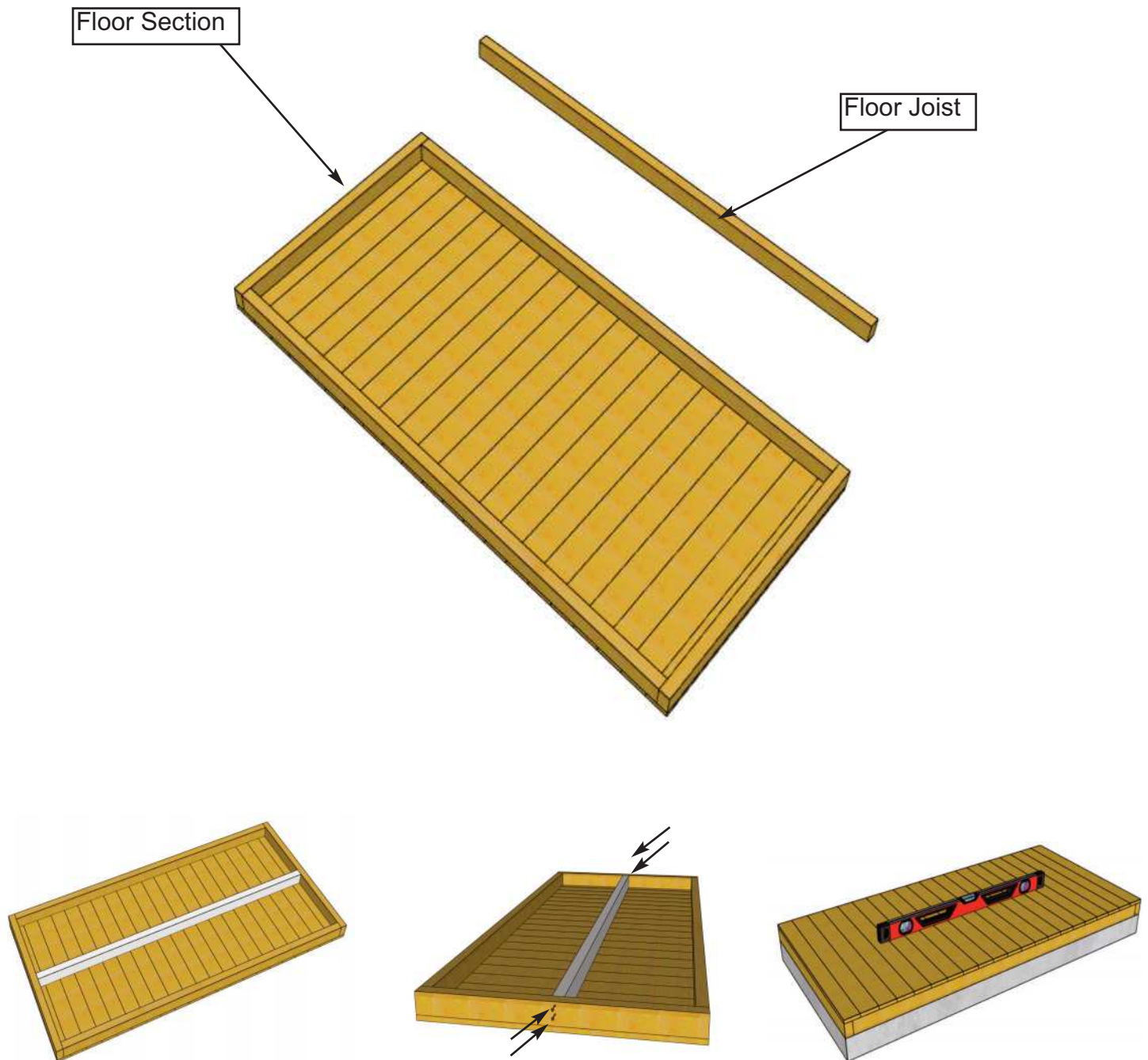

1. Locate **Floor Joist** and position at center of **Floor Section** and flush with framing as illustrated above. Attach with **2 - 2 1/2" Brown Screws** per end. Flip over and lay Floor Section on a level foundation only. Patio Stones or a Concrete Slab both make excellent foundations. (See Page 3 for more information on foundations). Use a level to confirm and shim Floor Joist as required.

Parts
Floor Joist
(1 1/2" x 2 1/2" x 70") x 1
Floor Section
(35" x 73") x 1

Hardware
2 1/2" Brown Screws
x 4 total

B. Wall Section

Exploded view of all parts necessary to complete the Wall Section. Identify all parts prior to starting.

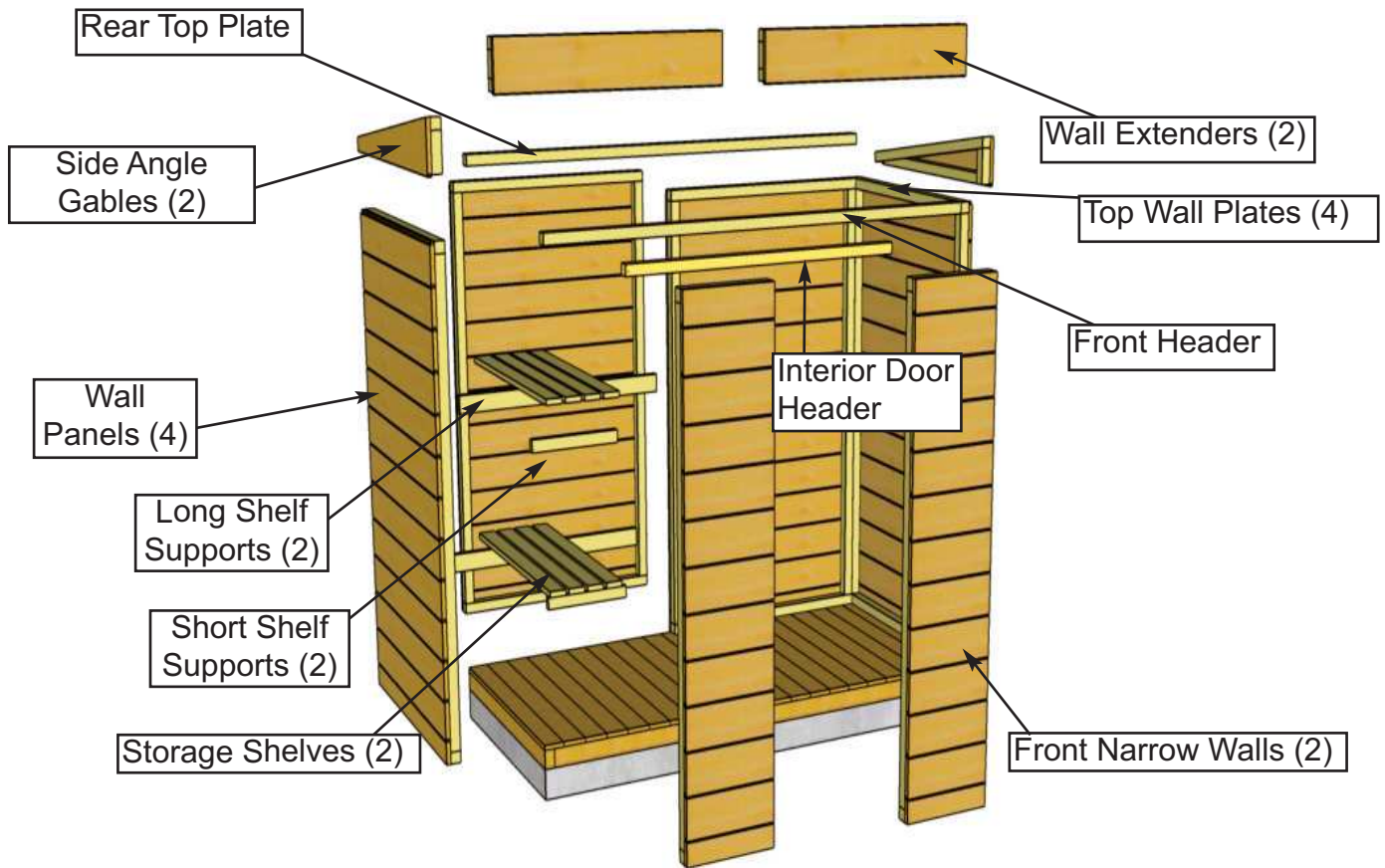

Due to packaging constraints, top wall plates must be attached prior to erecting walls.

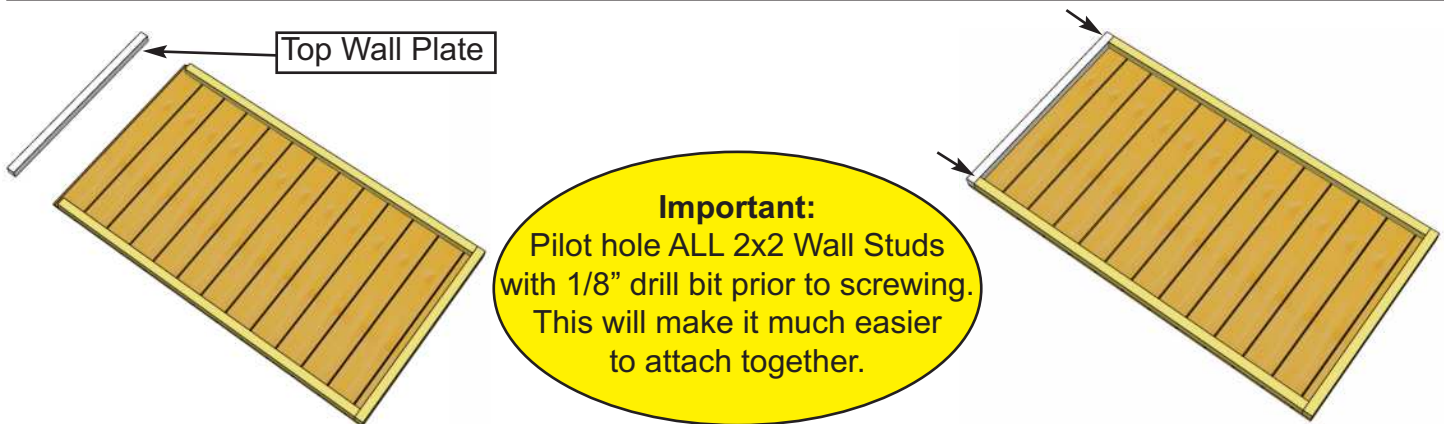

2. For each **Rear and Side Wall Panel**, carefully lay Panel face down. Position and attach a **Top Wall Plate** to top of wall studs of each Wall Panel with **2 - 2 1/2" Brown Screws**. Position so Plates are flush with framing.

Parts	Hardware
Rear/Side Wall Panels (35" x 63 1/4") x 4 Top Wall Plates (1 1/2" x 1 1/2" x 35") x 4	2 1/2" Brown Screws x 8 total

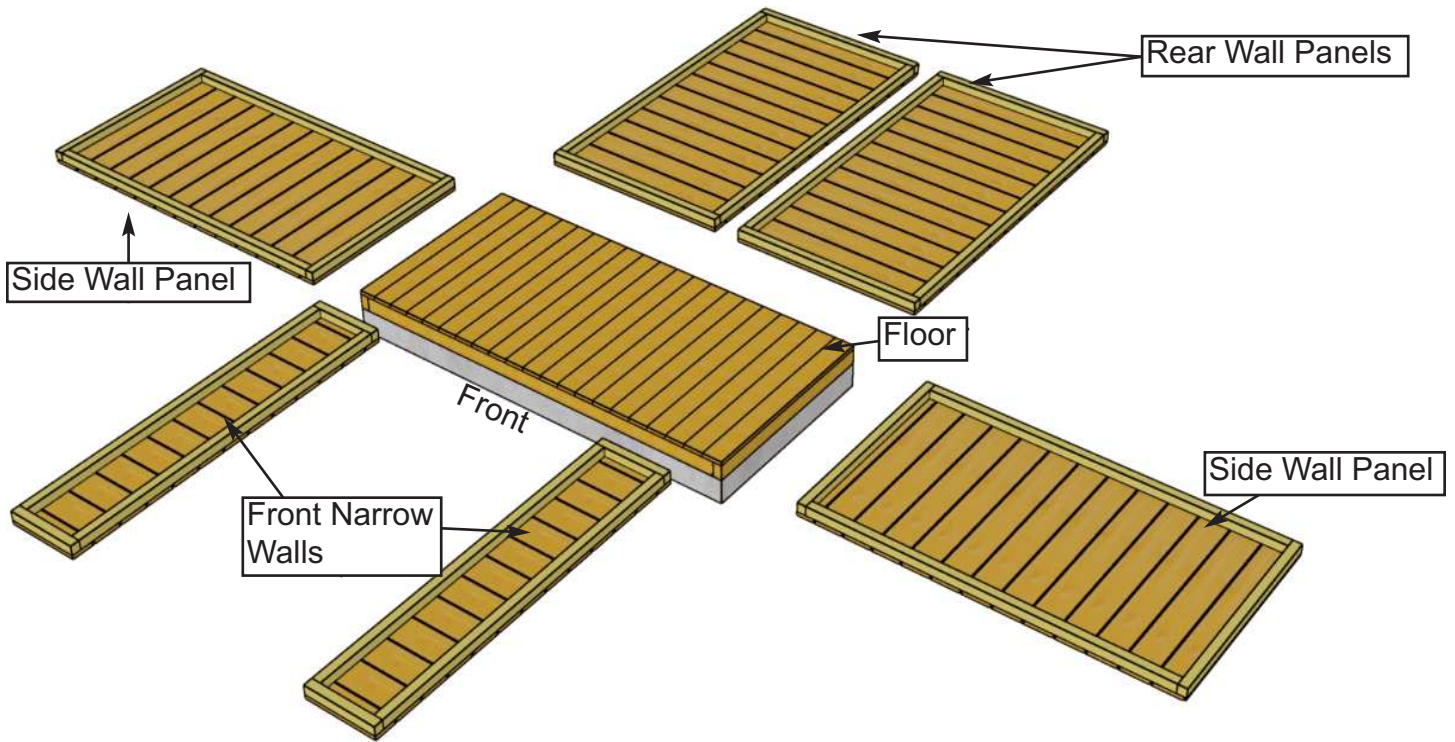

3. With Wall Plates properly attached, orientate completed Walls around the Floor. Be sure to leave room to work. **Front Narrow Walls** will be required in this section.

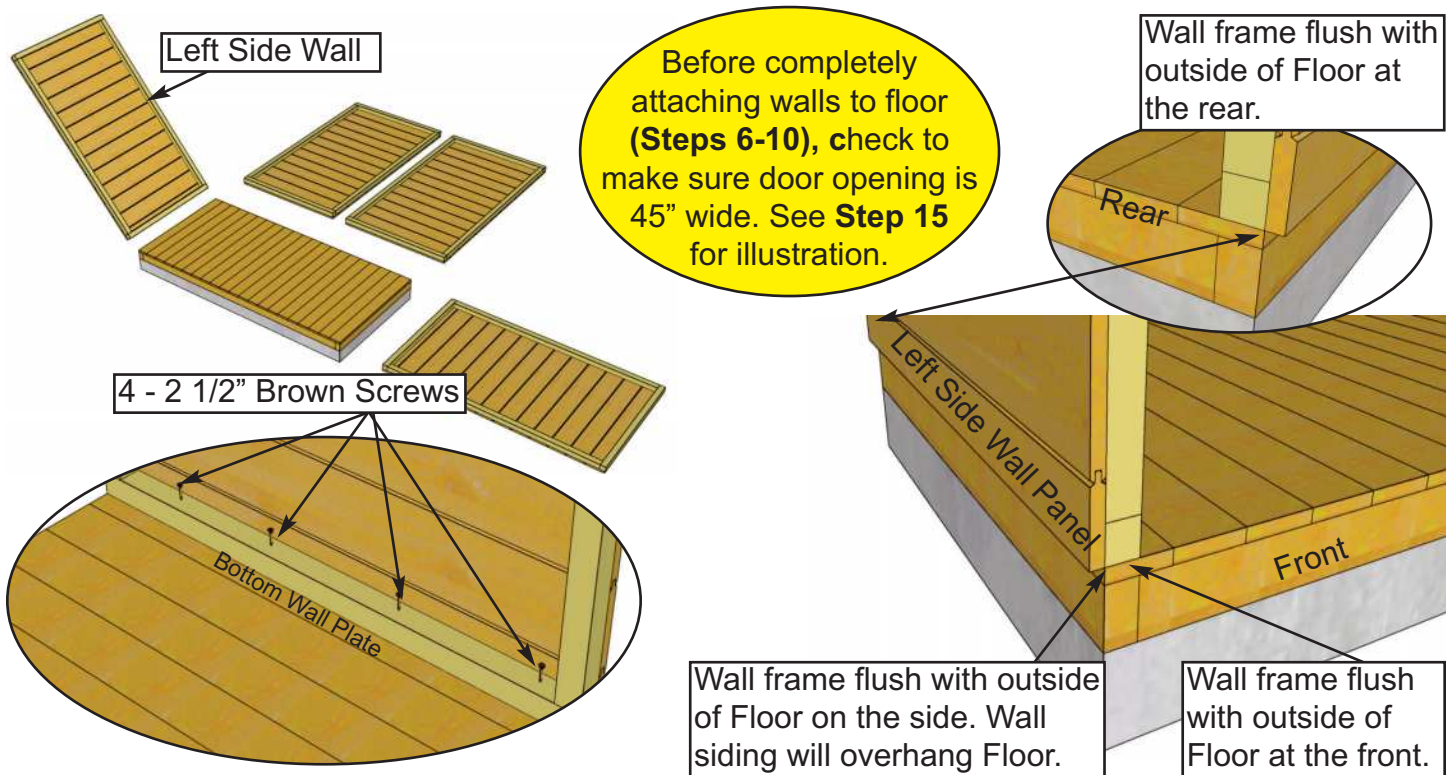

4. Starting with **Left Side Wall**, lift up and position so framing is flush with Floor at both front and rear of shed. Make sure Wall frame is flush with outside of Floor on the side. When Wall is positioned correctly, secure Bottom Wall Plate to Floor with **4 - 2 1/2" Brown Screws**.

Hardware (Steps 4 - 8)
2 1/2" Brown Screws
 x 25 total

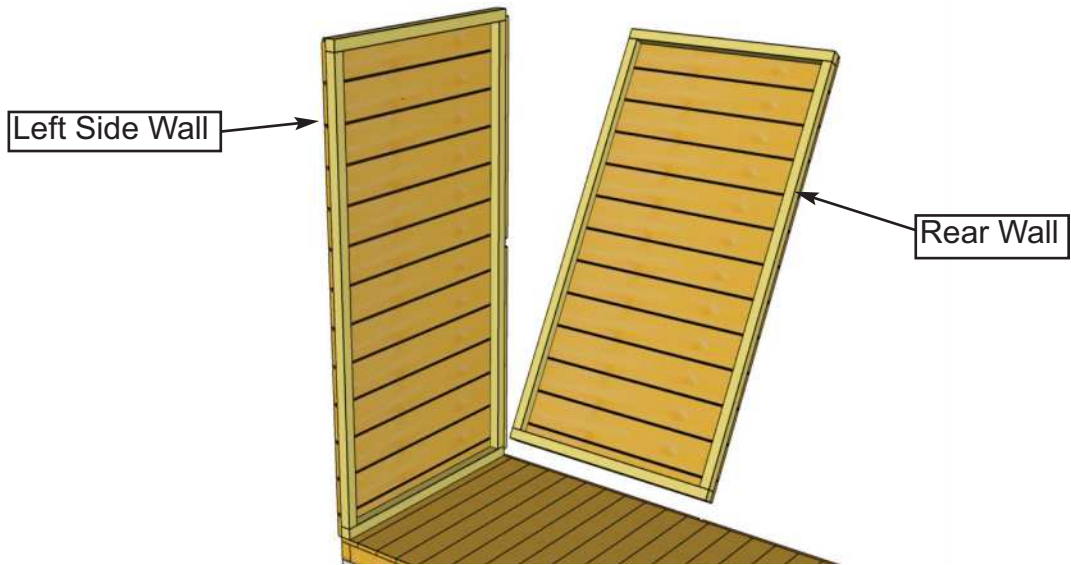

5. With your helper holding the Side Wall Panel, position a **Rear Wall Panel** in rear corner. **Important: Align Wall Framing Flush with Floor Framing.**

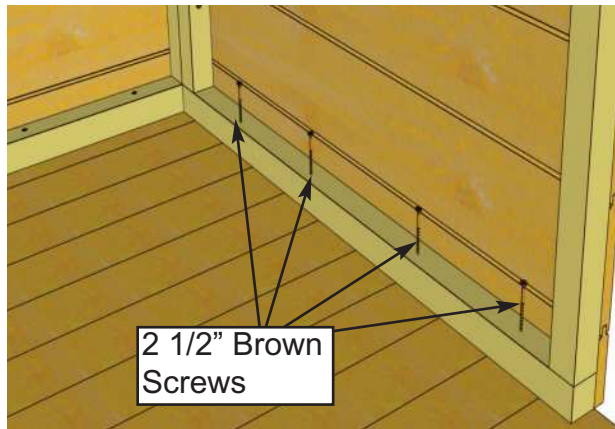
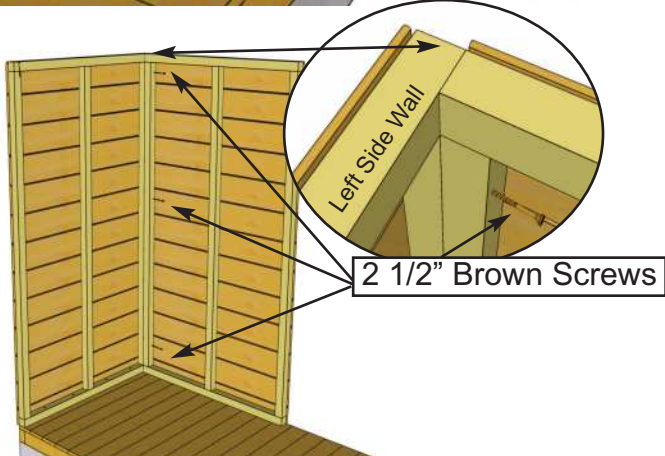
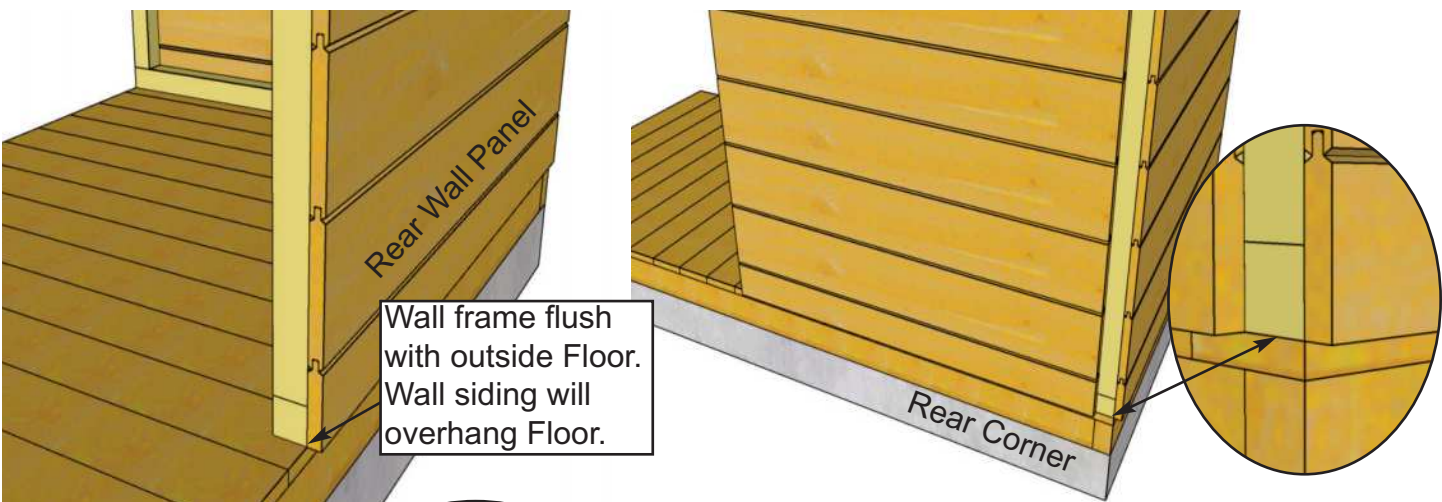

6. When Side and Rear Walls are aligned in corner correctly, Wall framings will be flush. Attach Wall framings together with **3 - 2 1/2" Brown Screws**. Secure Bottom Wall Plate to Floor with **4 - 2 1/2" Brown Screws**.

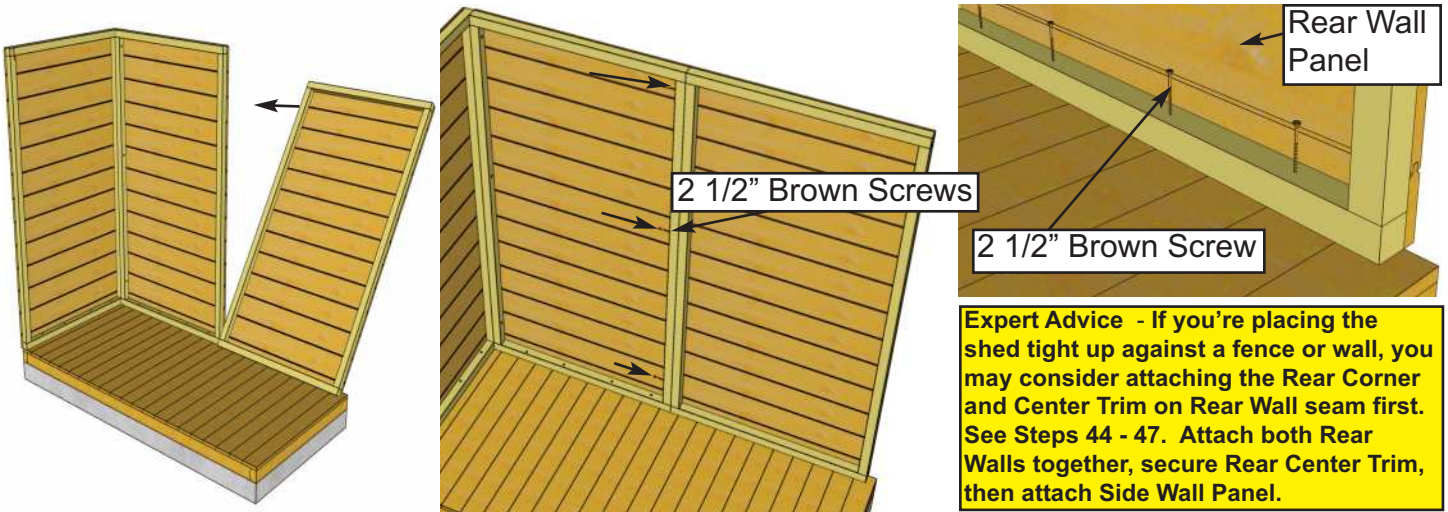

7. Position second **Rear Wall Panel** on Floor as per **Step 6**. Attach Wall frames together at top, middle and bottom with **3 - 2 1/2" Brown Screws**. Secure Bottom Wall Plate to floor with **4 - 2 1/2" Brown Screws**. **Important: Confirm Siding on Rear Wall Panels are aligned.**

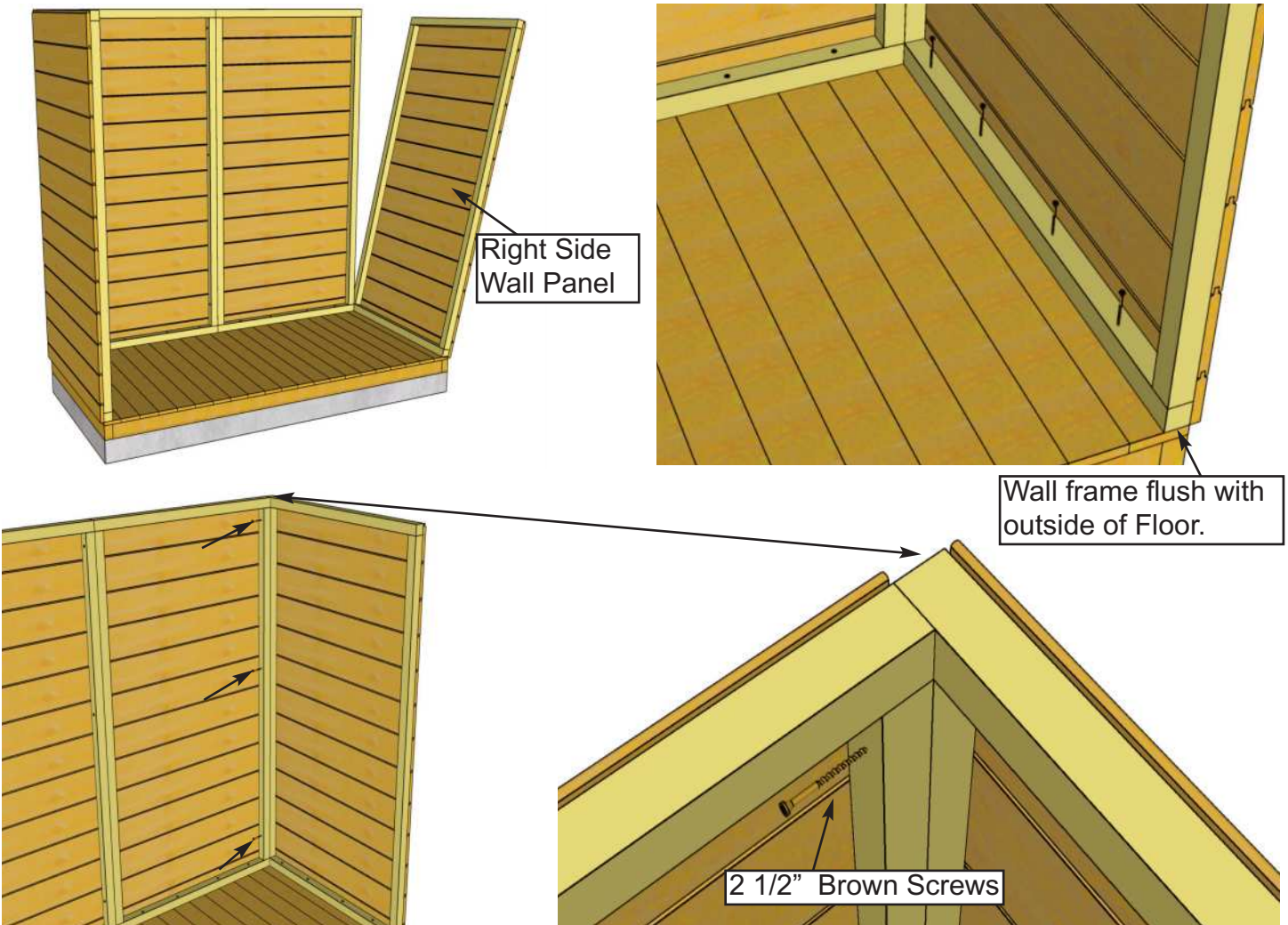

8. In the corner, align and attach Right Side Wall framing to Rear Wall framing with **3 - 2 1/2" Brown Screws** as per **Step 6**. Secure Bottom Wall Plate of Side Wall to Floor with **4 - 2 1/2" Brown Screws**.

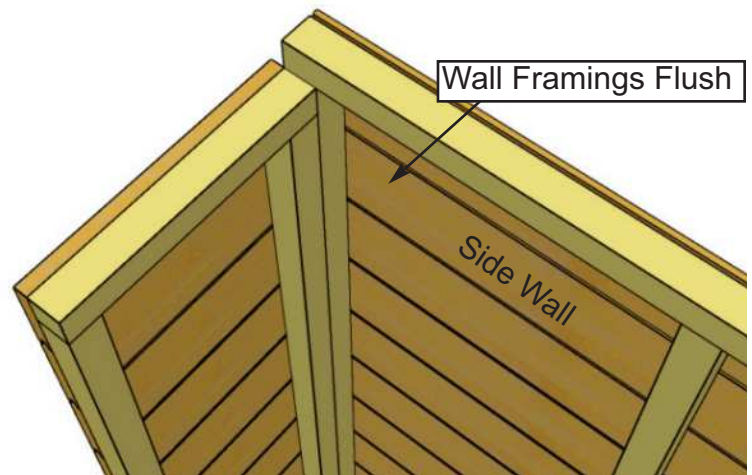
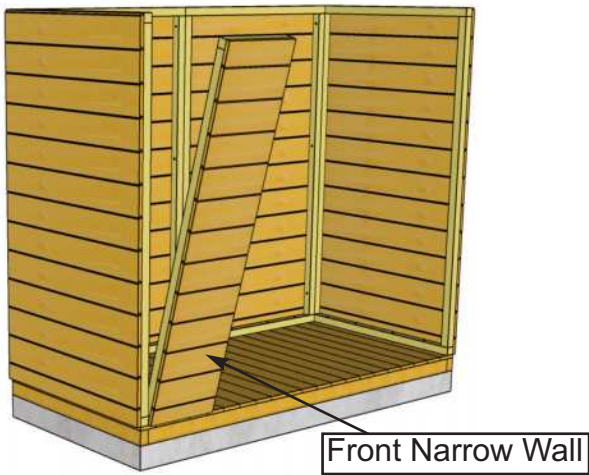

9. Locate **Front Narrow Walls** and position Wall framing flush with Side Wall framing in corner. **Important: Make sure Narrow Wall is positioned right side up.**

Parts (Steps 9 - 11)
Front Narrow Wall Panels
 (12 1/2" x 61 3/4") x 2

Hardware (Steps 9 - 11)
2 1/2" Brown Screws
 x 10 total

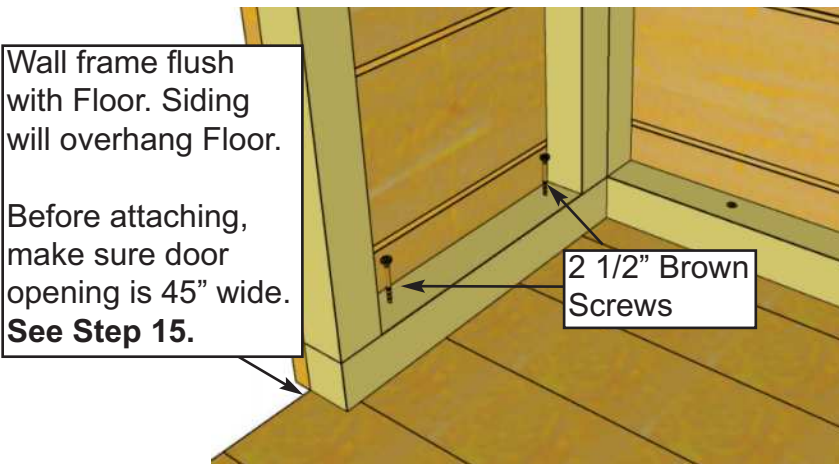

10. Align Wall framing flush with outside of Floor framing. When correctly positioned, secure Bottom Wall Plate to Floor with **2 - 2 1/2" Brown Screws**. Attach vertical Wall framings together at top, middle and bottom with **3 - 2 1/2" Brown Screws**.



11. Align and attach the second **Front Narrow Wall Panel** as per **Step 10**.

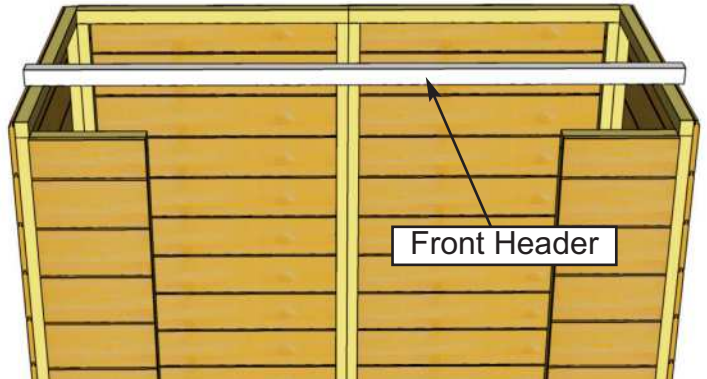

12. Locate **Front Header** and place on top of Front Narrow Wall framings.

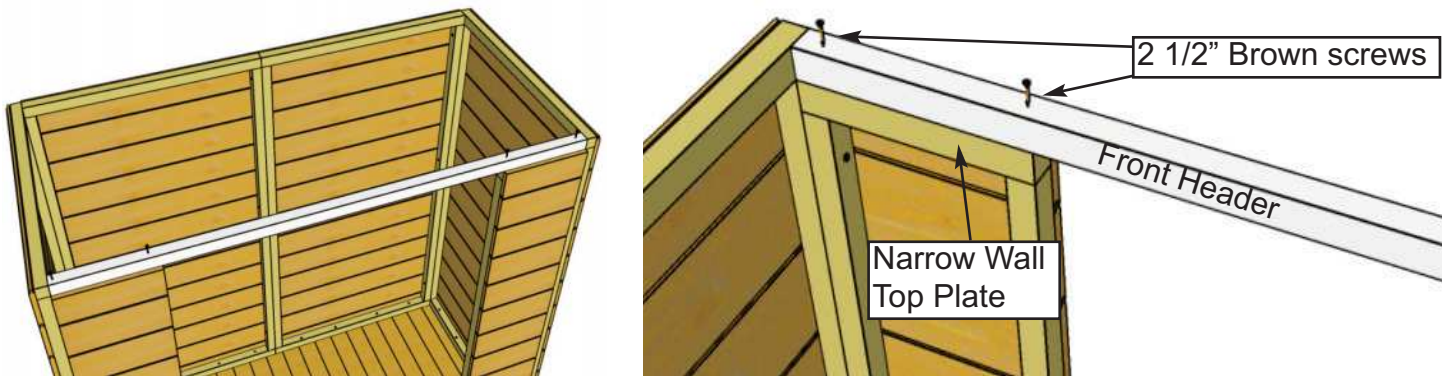

13. With Front Header positioned evenly on Narrow Wall top plates and flush against Side Wall top framing, secure using **4 - 2 1/2" Brown Screws** screwing down from the top of Front Header down into the upper Narrow Wall plates. Have your helper push side walls against end of Front Header to achieve tight fit if possible.

<u>Parts</u> Front Header (1 1/2" x 1 1/2" x 70")	<u>Hardware</u> 2 1/2" Brown Screws x 4 total
--	--

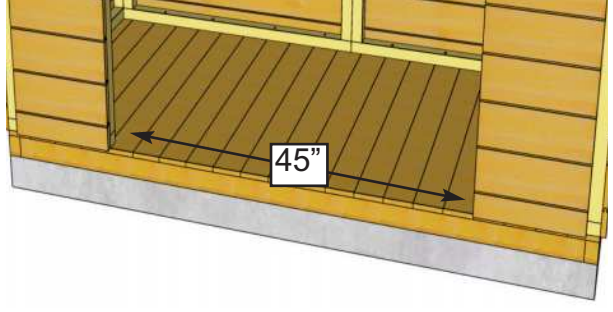
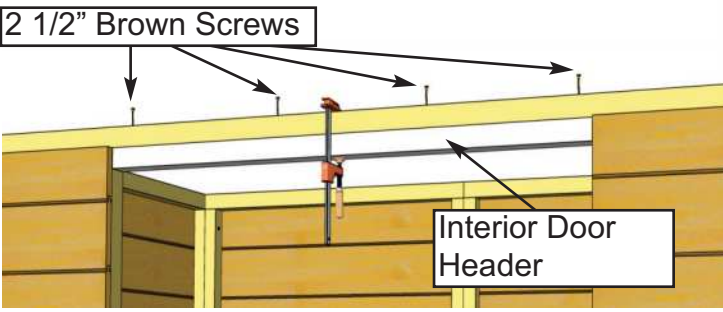

14. Position **Interior Door Header** underneath and flush with Front Header. Attach with **4 - 2 1/2" Brown Screws**. Screw down from the Front Header into Interior Door Header. Use Clamp to hold Interior Door Header.

15. When all Walls are attached together, check door width at top and bottom. Door width should be 45" wide. If required, loosen Narrow and Side Wall plate screws, adjust door width and re-secure. There can be an 1/8" tolerance in the width but top and bottom width should be the same.

<u>Parts</u> Interior Door Header (1 1/2" x 1 1/2" x 44 7/8")	<u>Hardware</u> 2 1/2" Brown Screws x 4 total
--	--

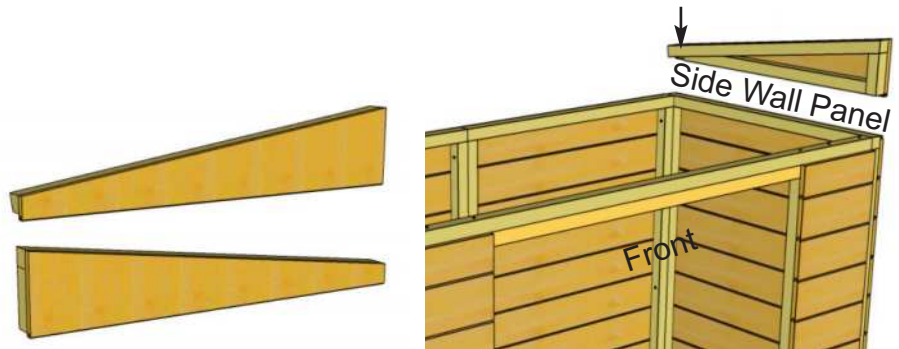

16. Locate both **Left/Right Side Angle Gables**. Place Right Side Angle Gable on Side Wall Panel frame. **Note:** Bottom siding of Gable will overhang and cover siding of Side Wall.

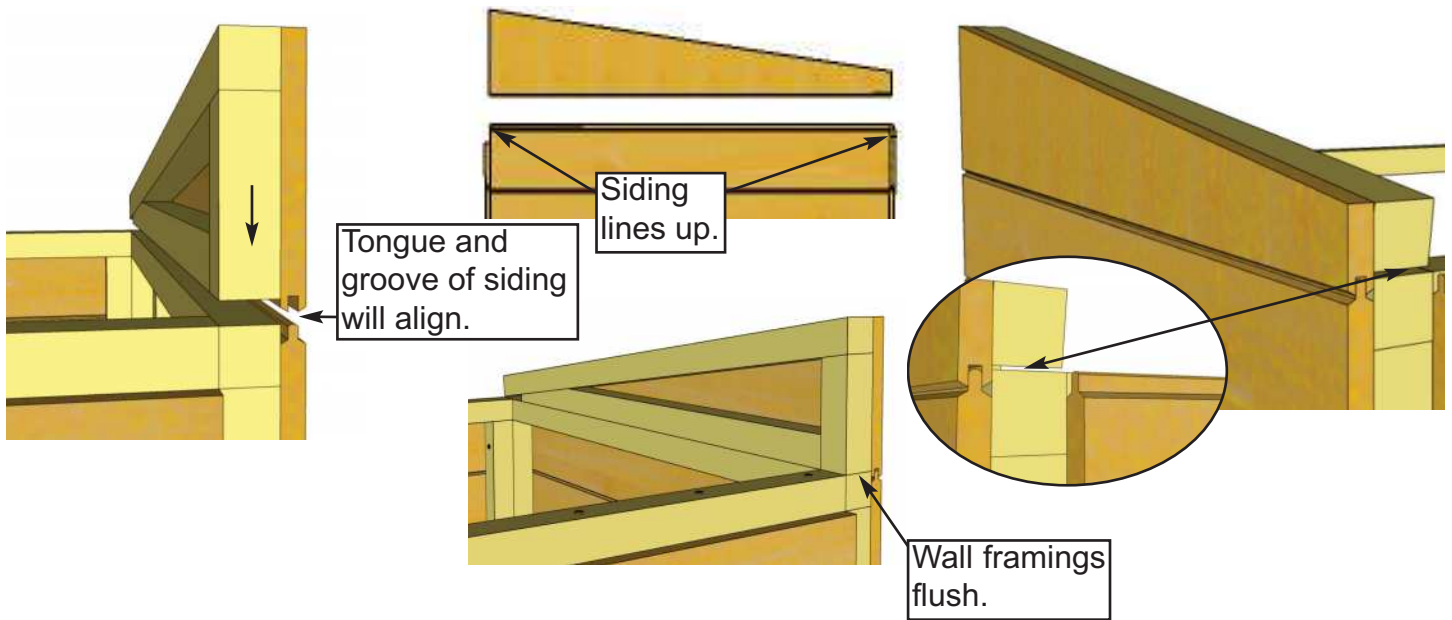

17. Align Wall framing of Right Side Angle Gable and Side Wall so they are flush at the front. The siding for both Walls should also align evenly from front to back.

<p><u>Parts (Steps 17 - 19)</u> Left/Right Side Angle Gables (6 1/2" x 35")</p>	<p><u>Hardware (Steps 17 - 19)</u> 2 1/2" Brown Screws x 8 total</p>
--	---

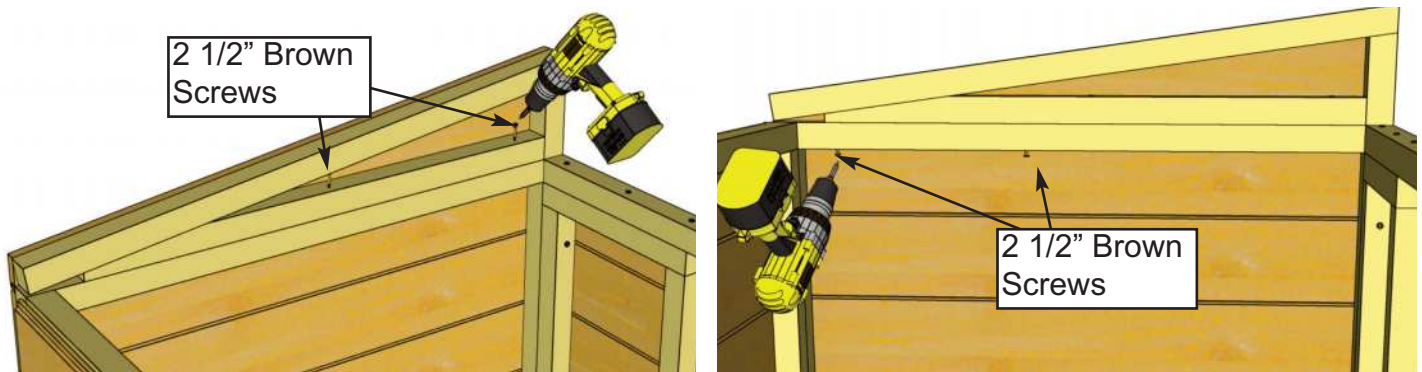

18. With Right Side Angle Gable and Side Wall aligned correctly, secure together from the inside with **4 - 2 1/2" Brown Screws**.

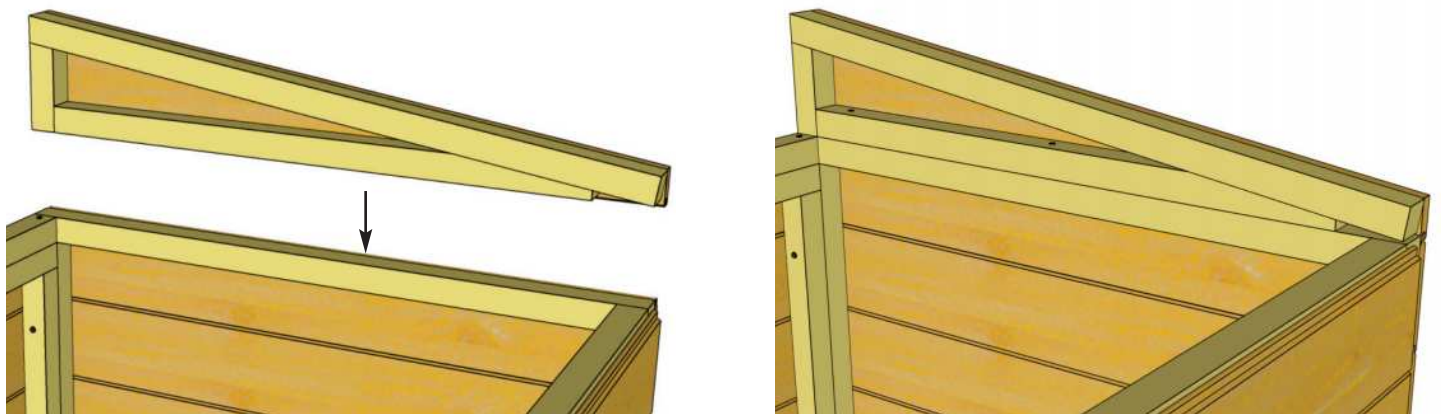

19. Complete opposite **Left Side Angle Gable** positioning and attachment as per **Steps 17 & 18**.

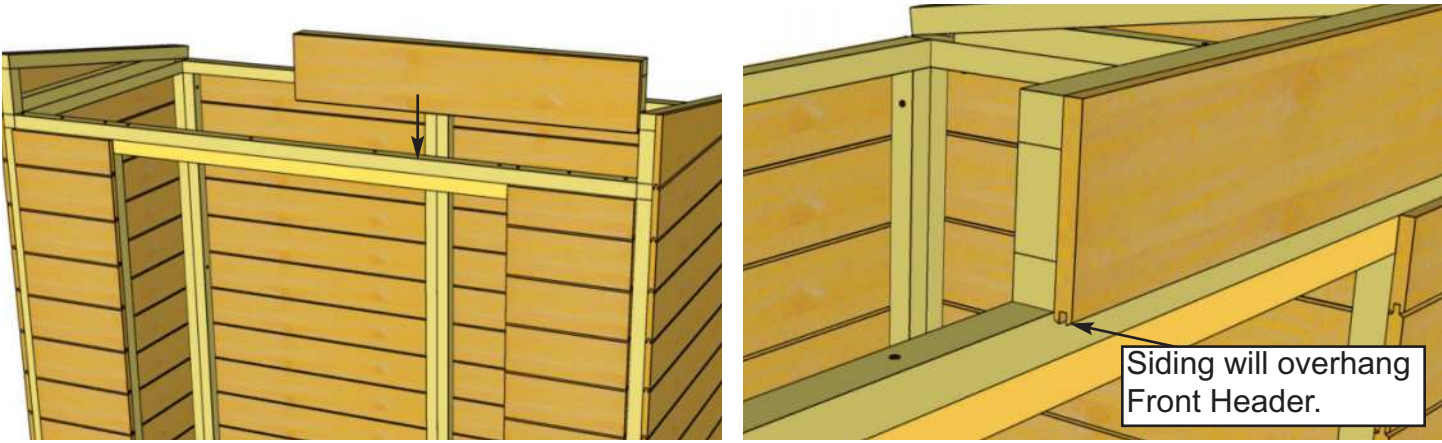

20. Locate one **Wall Extender** and place on Front Header with siding of Wall Extender overhanging Front Header.

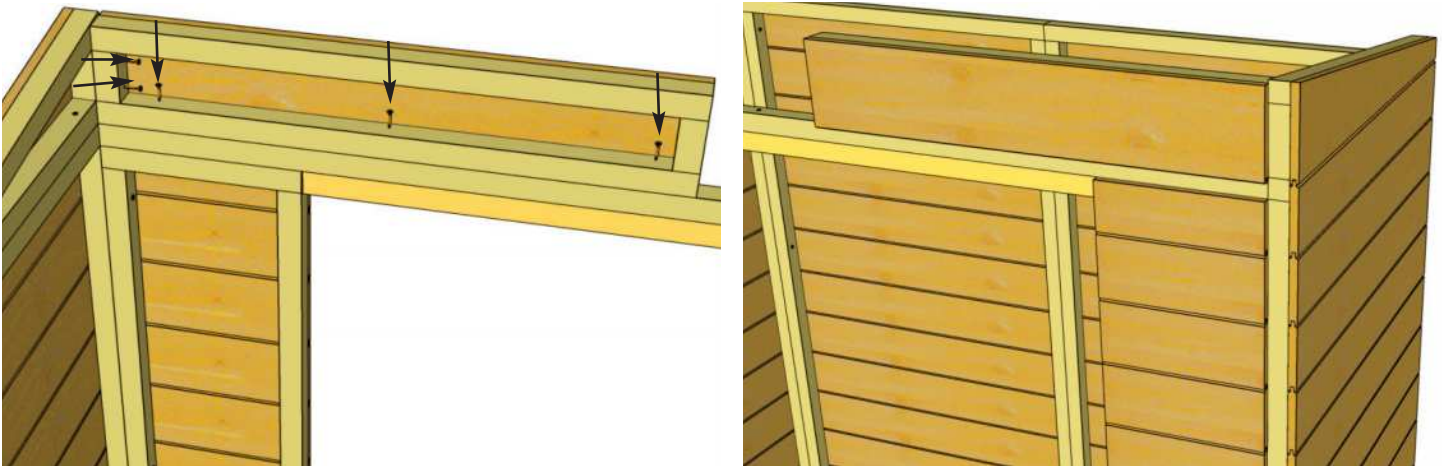

21. With Wall framing aligned, attach Wall Extender to both the Right Side Angle Gable framing and the Front Header with **5 - 2 1/2" Brown Screws**.

<p><u>Parts (Step 21 - 22)</u> Wall Extenders (6 1/4" x 35") x 2</p>	<p><u>Hardware (Step 21 - 22)</u> 2 1/2" Brown Screws x 12 total</p>
---	---

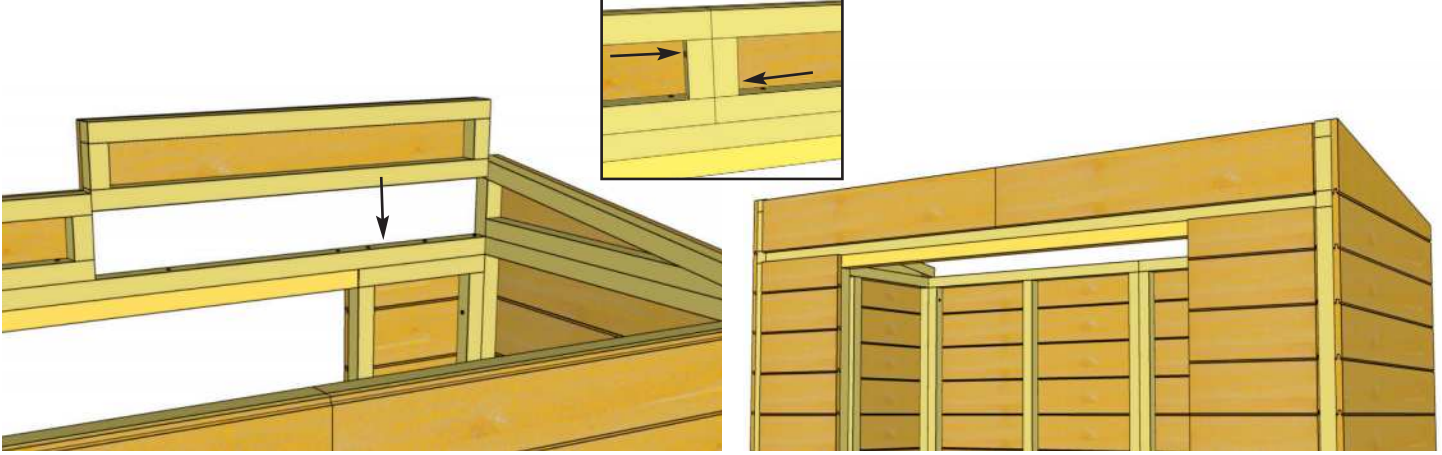

22. Position and secure second **Wall Extender** as per **Steps 20 & 21**. Additionally, attach to first Wall Extender with **2 - 2 1/2" Brown Screws**.

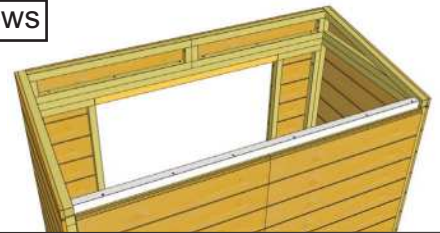
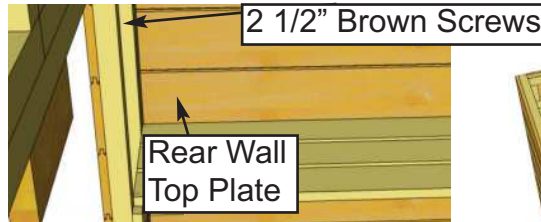
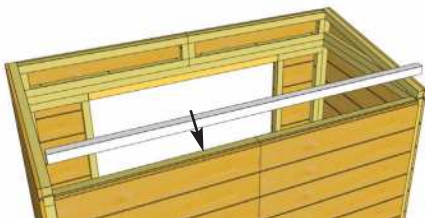

23. Locate **Rear Top Plate** and place on top of Rear Walls. With Rear Top Plate positioned evenly and flush against Rear Wall framing, secure using **6 - 2 1/2" Brown Screws** screwing down from the top of Rear Top Plate down into the Rear Wall top plates.

<u>Parts</u> Rear Top Plate (1 1/2" x 1 1/2" x 70")	<u>Hardware</u> 2 1/2" Brown Screws x 6 total
--	--

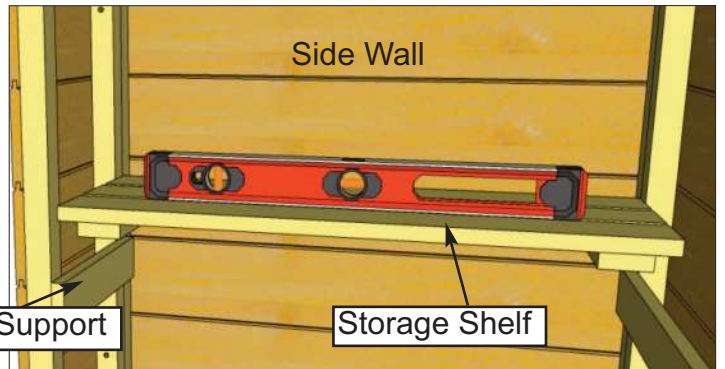
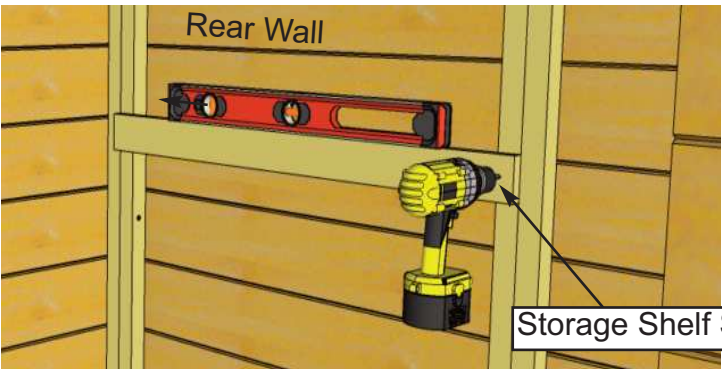

24. Storage Shelf positioning is flexible so decide what height configuration suits your needs. Gather your **Storage Shelf Supports**. The short Support (12 1/2") attaches to the Narrow Wall, the long (35") to the Rear Wall. Position using a Level, and drill Pilot Holes to prevent ends of Supports from splitting. Attach first Support using **2 - 1 1/4" Screws**. Place **Storage Shelf** on attached Support, Level, and mark position of second Support. Pilot Hole and secure second Support.

<u>Parts (Steps 24 - 25)</u> Short Storage Shelf Supports (3/4" x 2 1/2" x 12 1/2") x 2 Long Storage Shelf Supports (3/4" x 2 1/2" x 35") x 2 Storage Shelves (11 1/2" x 31 7/8") x 2	<u>Hardware Parts (Steps 24 - 25)</u> 1 1/4" Brown Screws x 8 total 1 1/2" Finishing Nails x 8 total
--	--

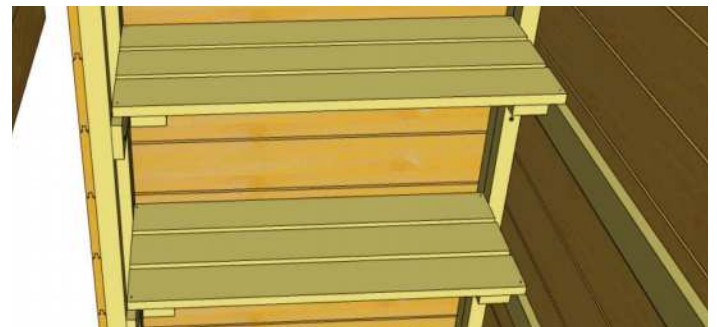

25. Place **Storage Shelf** on top of supports and secure with **4 - 1 1/2" Finishing Nails**. Complete 2nd Shelf (if desired) as per **Steps 24 & 25**.

C. Roof Section

Exploded view of all parts necessary to complete the Roof Section. Identify all parts prior to starting.

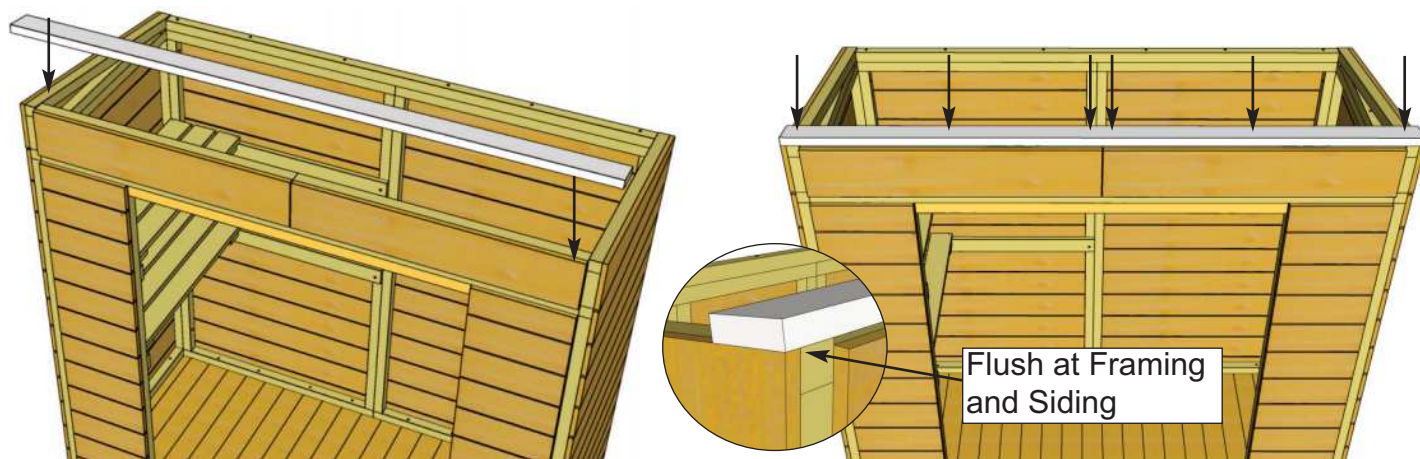
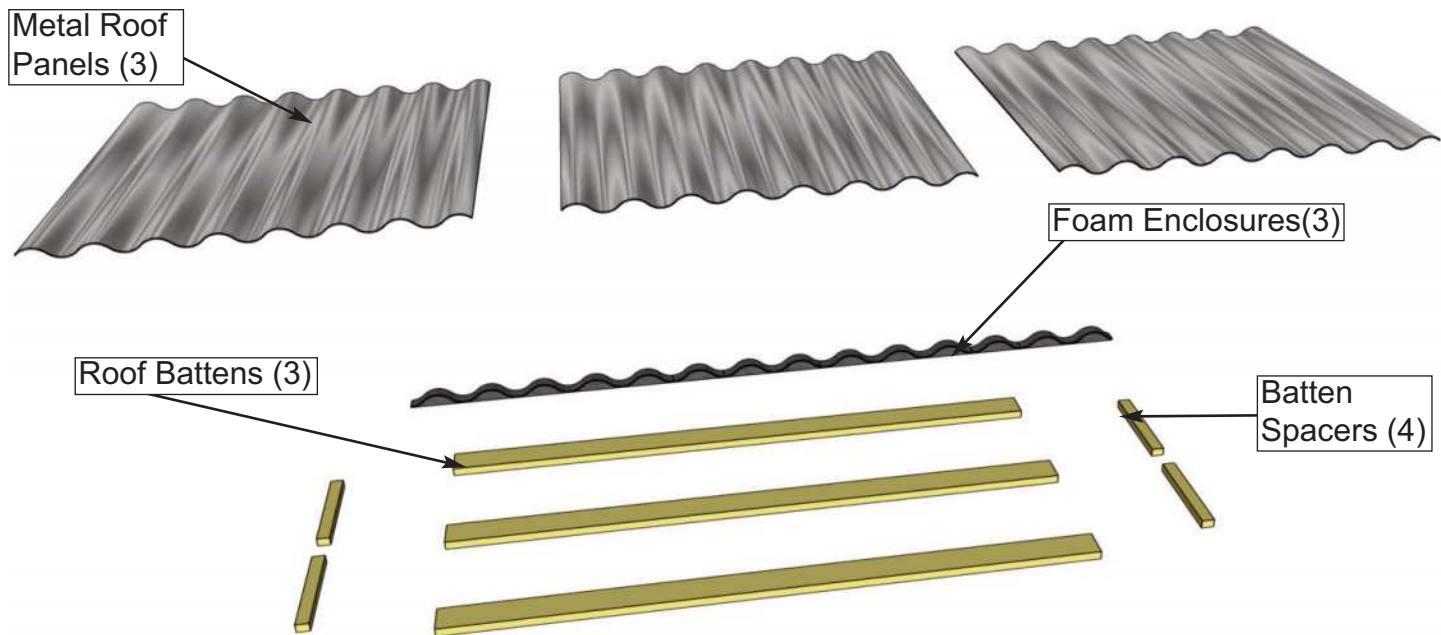

26. Locate first row of **Roof Battens** and position on top of Side Angle Gables and Wall Extenders at the front. Batten will sit flush with framing at front and flush with siding of Side Angle Gable at the side. Attach **Batten** with **6 - 1 1/4" Brown Screws**, one at each end into top of Side Angle Gable, and into framing of Wall Extender. **Important** pre-drill pilot hole with 1/8" drill bit first to prevent from splitting.

<p><u>Parts (Step 26 - 29)</u> Battens (3/4" x 3 1/2" x 74 1/4") x 3 Batten Spacers (3/4" x 1 1/2" x 12 3/8") x 4</p>	<p><u>Hardware (Step 26 - 29)</u> 1 1/4" Brown Screws x 22 total</p>
---	---

Important: Pre-drill Batten Spacers with 1/8" bit before fastening.

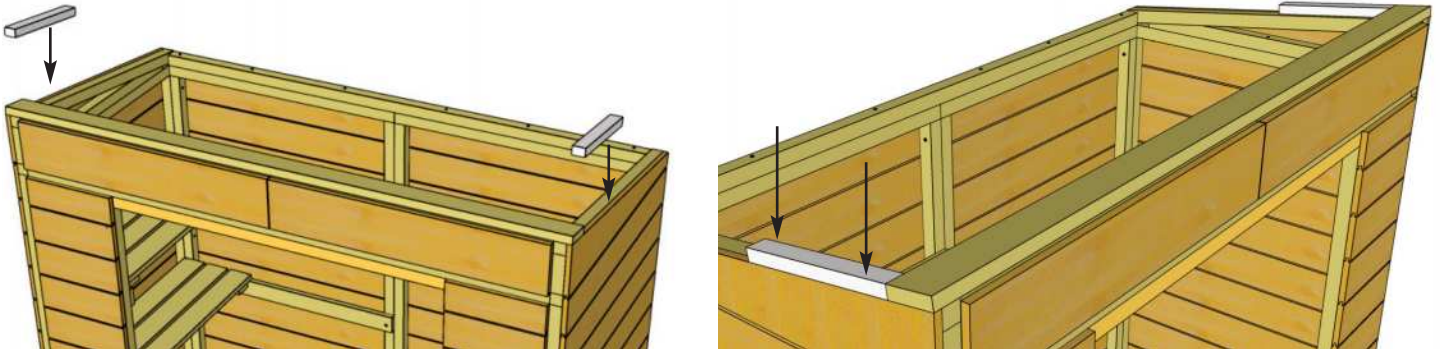

27. Place 2 **Batten Spacers** below each end of the attached Batten, lengthwise along Side Angle Gable. Ensure Batten Spacer is tight with Batten. Attach Batten Spacer to top of Side Angle Gable using 2 - 1 1/4" **Brown Screws**.

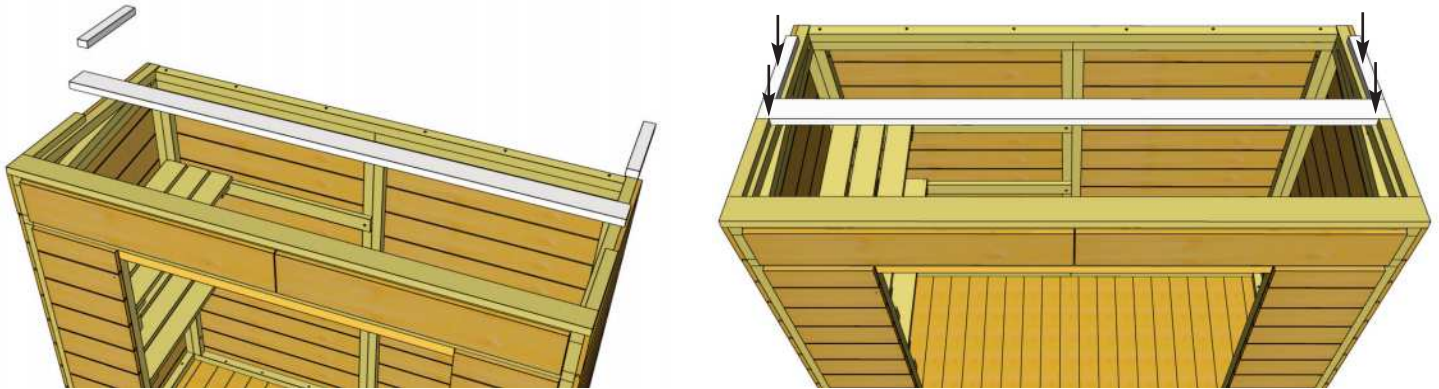

28. Locate another **Roof Batten** and position flush with previously attached Batten Spacers. Attach with 2 - 1 1/4" **Brown Screws**, one at each end into framing of Side Angle Gables. Attach a second row of **Batten Spacers** flush with the bottom edge of this middle Batten row via the same method as **Step 27**.

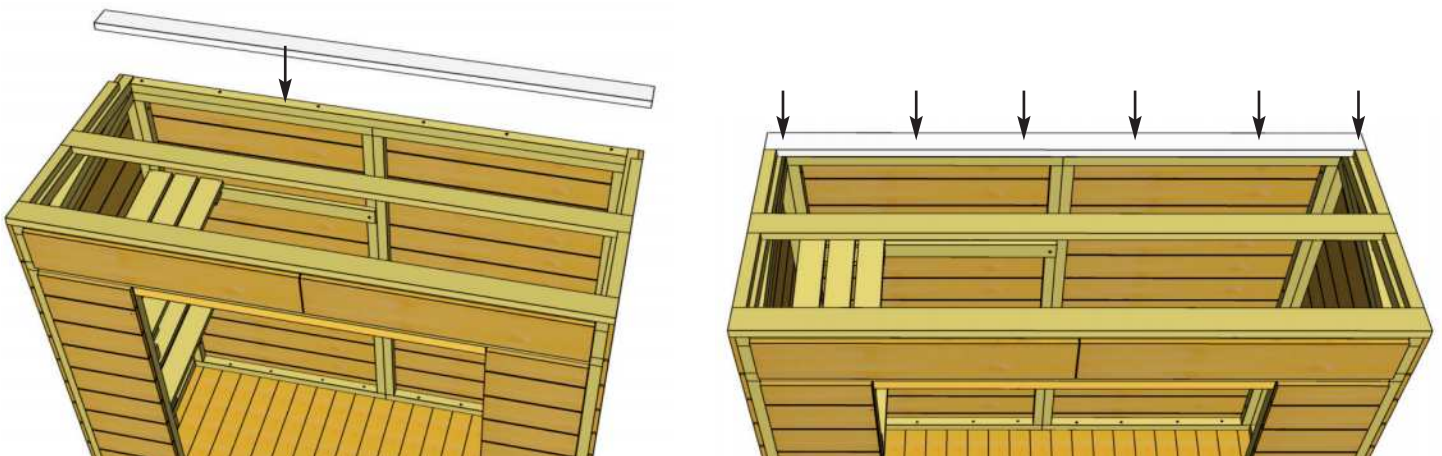

29. Locate the last **Roof Batten** and attach flush with previously attached **Batten Spacers** via the same method as **Step 26**, using a total of 6 - 1 1/4" **Brown Screws**.

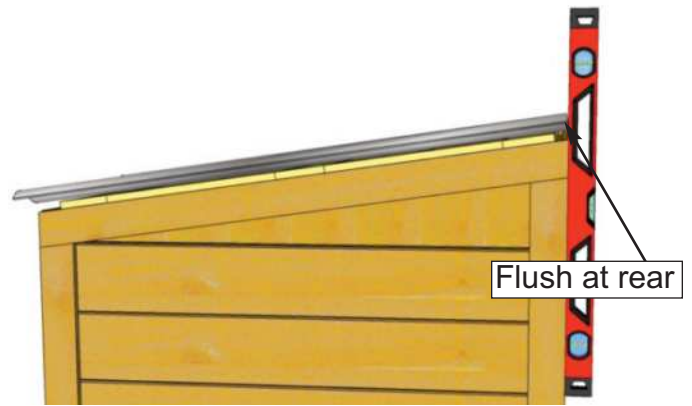
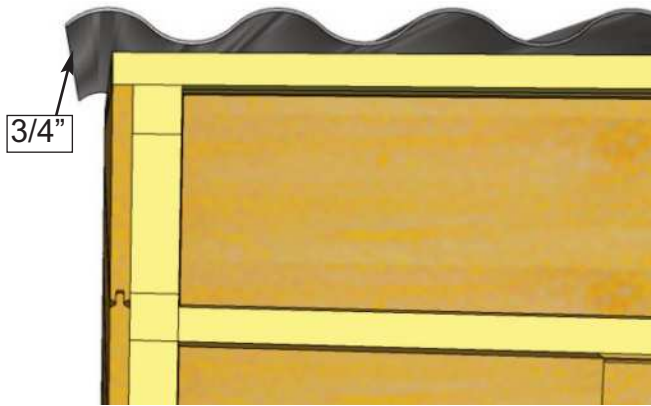

30. Locate first **Metal Roof Panel** and place on Battens. Overhang the Metal Roof Panels past the Battens on the sides by approximately 3/4" and flush at the rear when Side Fascia and Rear Corner Trims are attached in later steps.

Parts (Steps 30 - 31)
Metal Roof Panel (39") x 3

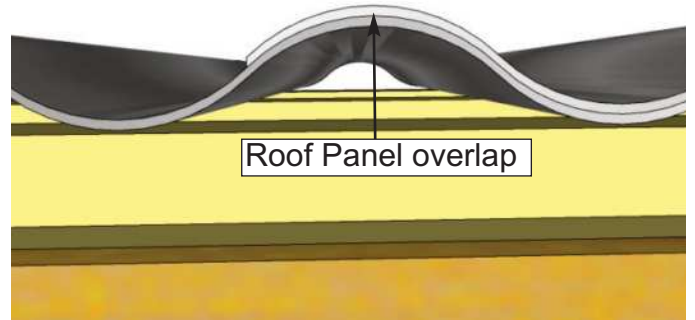

31. Make sure Metal Roof Panels are overlapping. Adjust the position of remaining Metal Roof Panels on Battens as per **Step 30**. Overlap Metal Roof Panels to achieve desired overall width. Overall width past the end of Battens can vary from 3/4" to 3" depending on your personal preference.

Screw into center of Battens.

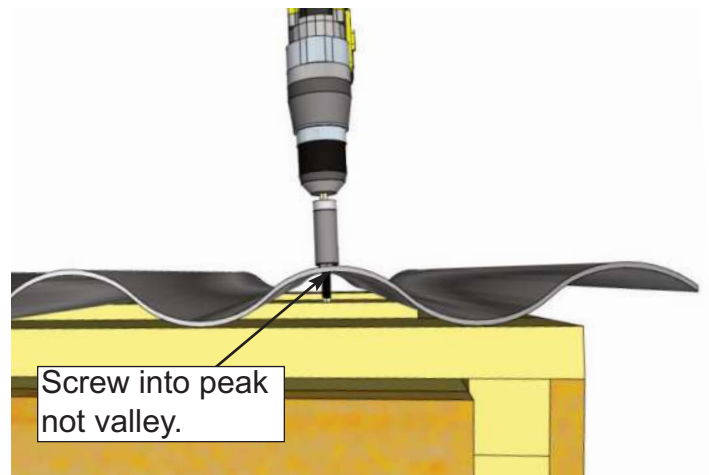
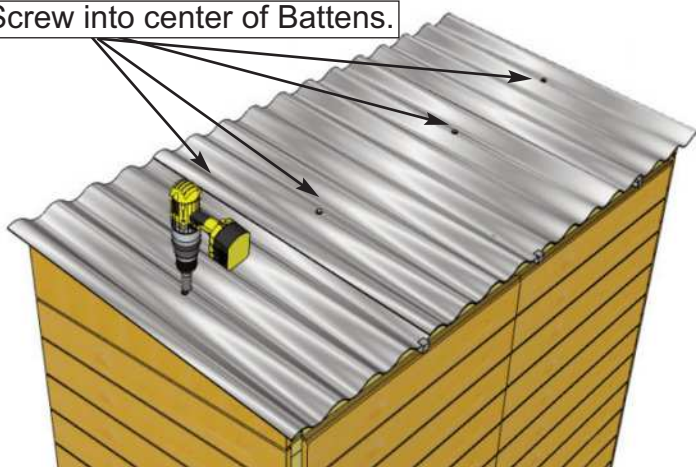

32. Using 4 - **2" Metal Roof Screws** and **1/4" Nut Driver** (included), secure Metal Roof Panels down to middle Batten row. Metal screw is self-tapping, do not overtighten. Screw through Roof Panels into center of Batten. Eight more **2" Metal Screws** will be required to further secure Metal Roof Panels and to complete **Metal Ridge Caps** in later steps.

Parts
2" Metal Roof Screws
 x 4
1/4" Nut Driver
 x 1

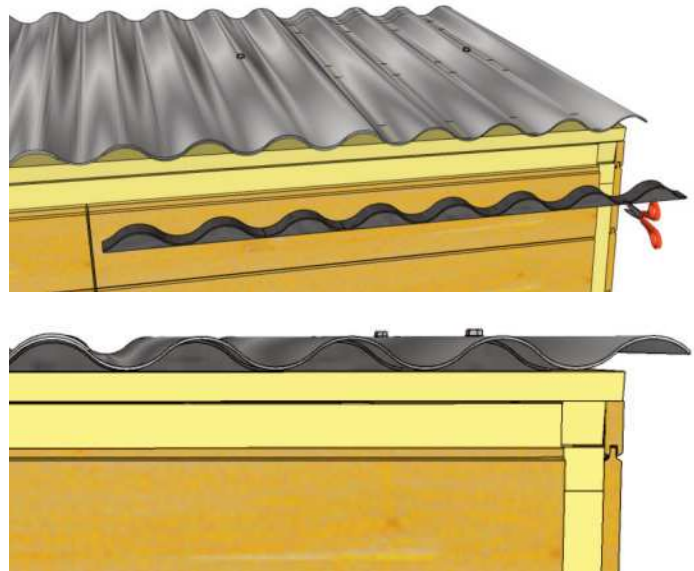
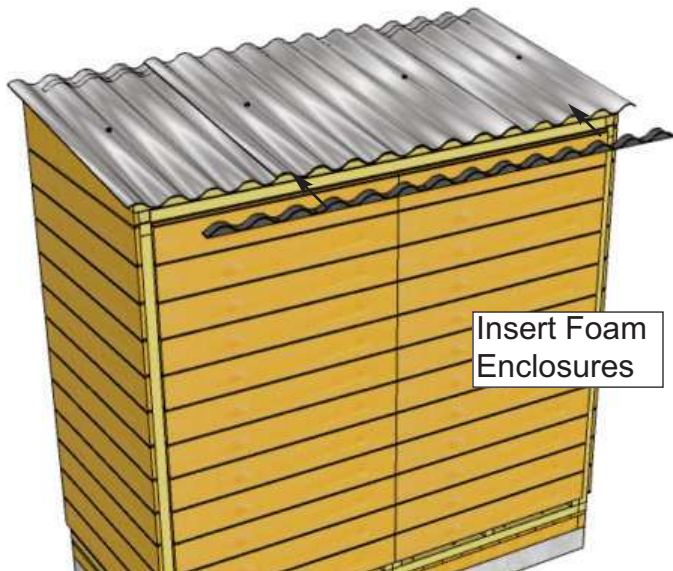

33. Insert **Foam Enclosures** between Metal Roof Panels and Battens at the Rear. Enclosures may need to be snipped down in length to fit. Enclosures will prevent moisture and unwanted bugs, etc. from entering your shed through here.

Parts
Foam Enclosures
 x 3

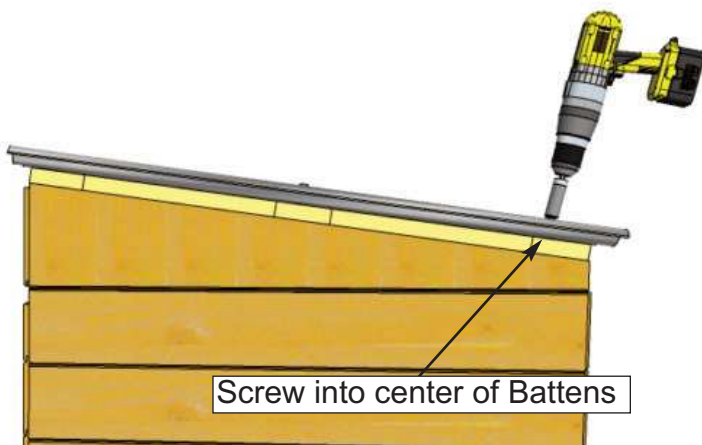

34. Using 4 - **2" Metal Roof Screws** and **1/4" Nut Driver**, secure Metal Roof Panels down to lower Battens. Metal screws are self-tapping, do not overtighten!

Parts
2" Metal Roof Screws
 x 4
1/4" Nut Driver
 x 1

D. Miscellaneous Section

Exploded view of all parts necessary to complete the Skirting, Trim, Fascia and Miscellaneous Pieces. Identify all parts prior to starting.

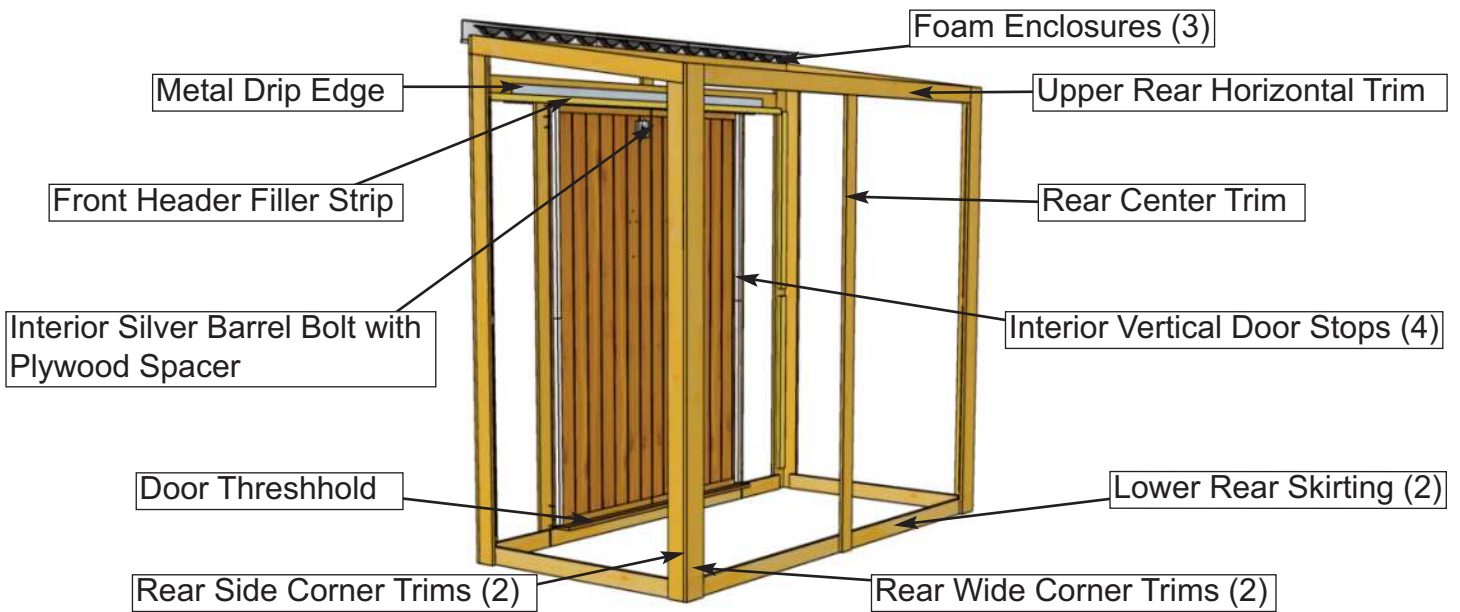
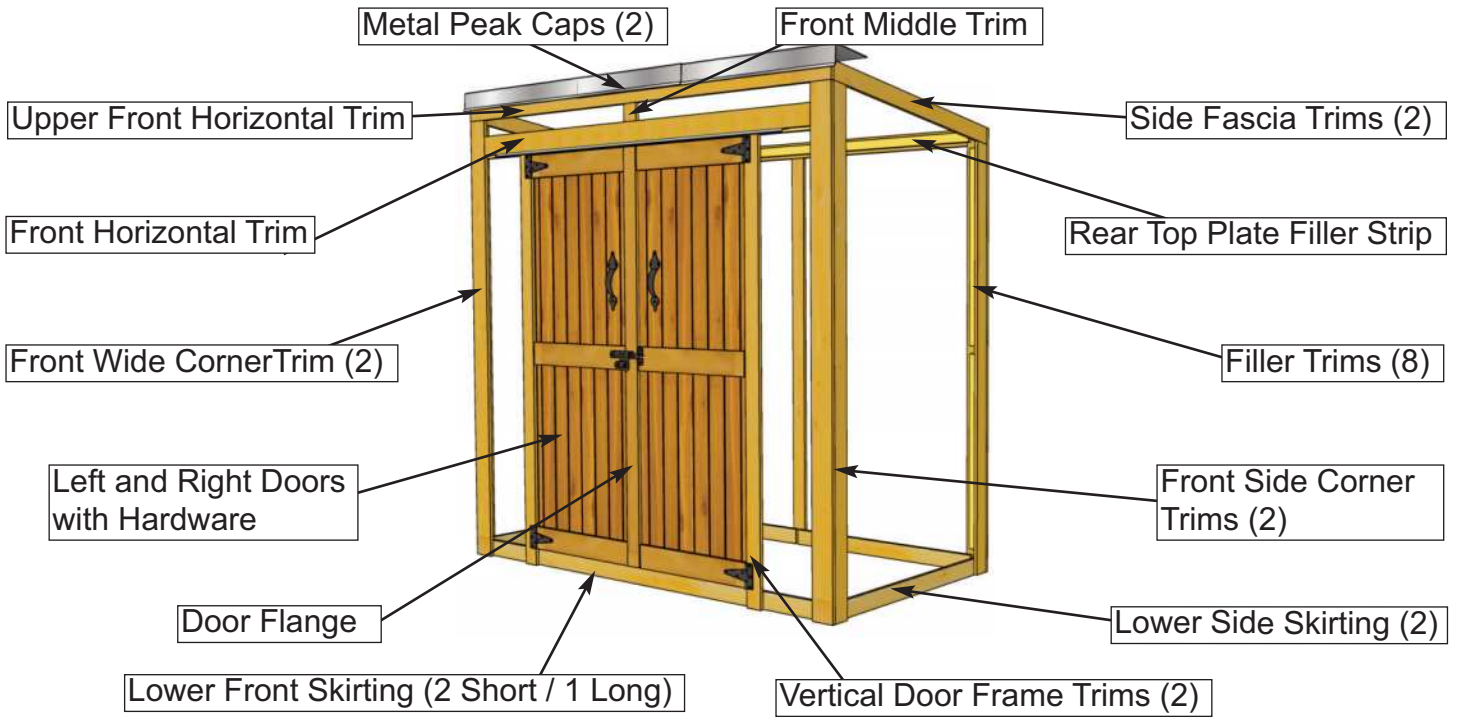

35. Check the wall seams for visible gaps prior to attaching Filler Trim and apply caulk where needed. Caulking gaps will help prevent moisture from entering and will help the longevity of your shed. **Caulking not included in kit.**

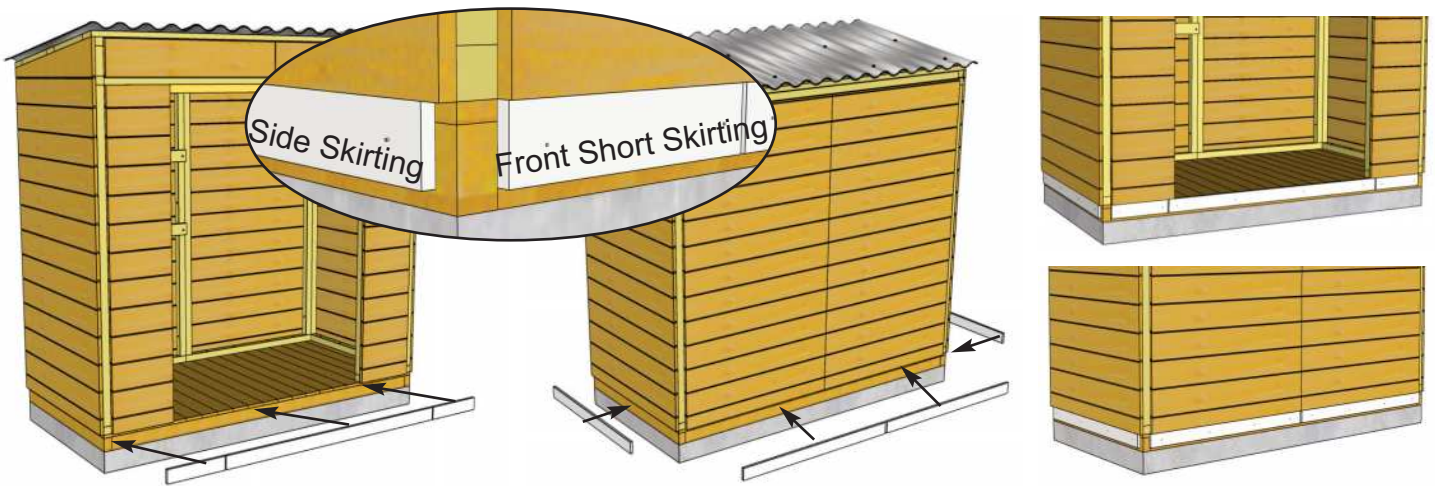

36. Locate **Lower Front Skirting (2 Short and 1 Long)**. Skirting will hide floor framing. Gaps will be covered by Wide Trim pieces later. Attach 2 Lower Short Front Skirting pieces with **2 - 1 1/2" Finishing Nails** per piece. Attach Lower Front Long Skirting with **4 - 1 1/2" Finishing Nails**. Locate **Lower Side and Rear Skirting** and attach with **4 - 1 1/2" Finishing Nails** per piece.

<u>Parts</u>	<u>Hardware</u>
Lower Front Skirting Short (1/2" x 2 1/2" x 11 1/8") x 2 Long (1/2" x 2 1/2" x 47 1/4") Lower Side Skirting (1/2" x 2 1/2" x 33") x 2 Lower Rear Skirting (1/2" x 2 1/2" x 35") x 2	1 1/2" Finishing Nails x 24 total

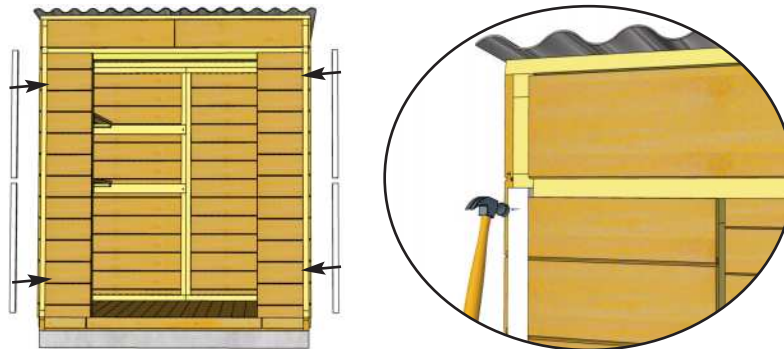

37. Locate 4 **Front Filler Trims**. Filler trim will be covered by Corner Trim in **Step 47**. Attach in each front corner with **3 - 1 1/2" Finishing Nails** per piece.

<u>Parts (Step 37 - 38)</u>	<u>Hardware (Step 37 - 38)</u>
Front/Rear Filler Trims (5/8" x 1 1/2" x 30") x 8	1 1/2" Finishing Nails x 24 total

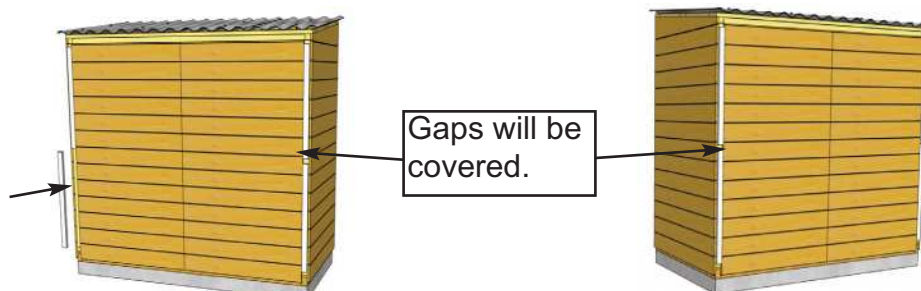

38. Position and attach **Rear Filler Trims** in the rear as per **Step 37**.

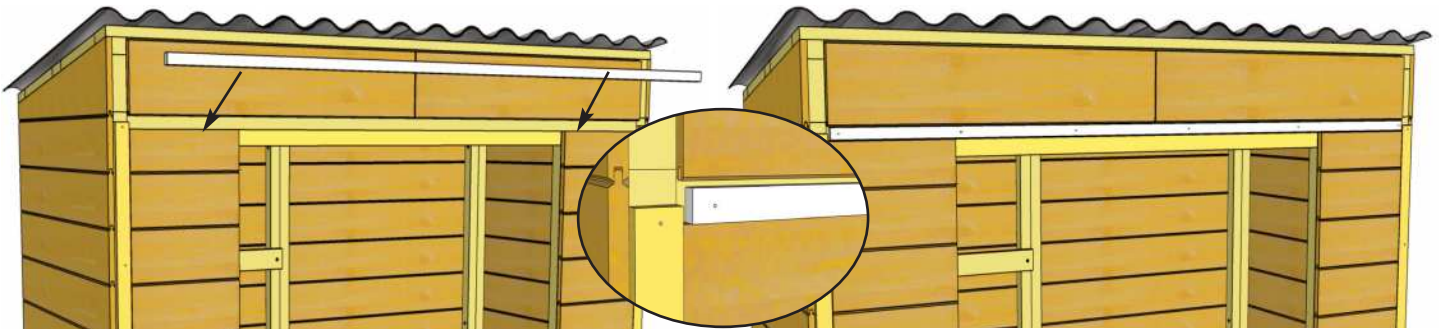

39. Locate **Front Header Filler Strip**. Position Front Header Filler Strip between Front Narrow Walls and Wall Extenders. Evenly space from side to side. Secure with **6 - 1 1/2" Finishing Nails** into Front Header.

<u>Parts</u> Front Header Filler Strip (5/8" x 1" x 69 1/2")	<u>Hardware</u> 1 1/2" Finishing Nails x 6 total
---	---

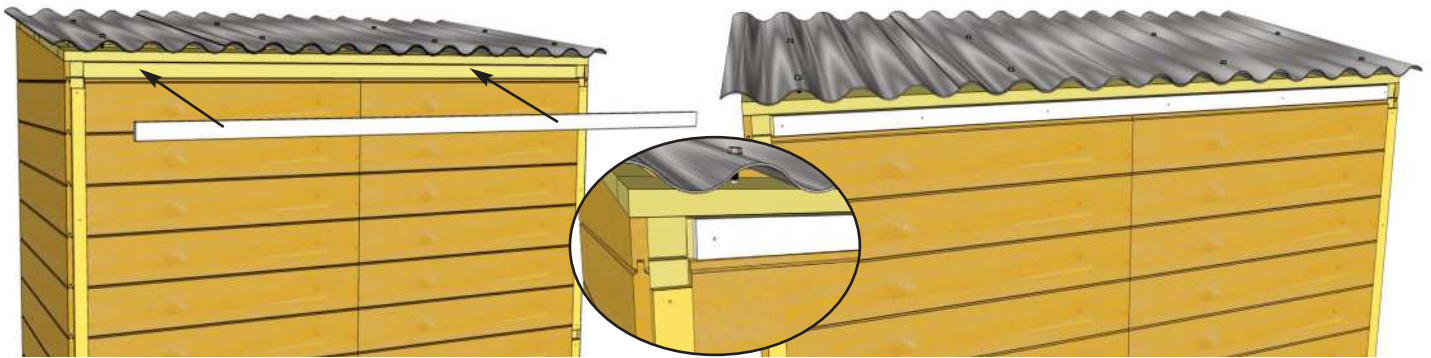

40. Locate **Rear Top Plate Filler Strip**. Position between Rear Walls and Metal Roof. Evenly space from side to side. Secure with **6 - 1 1/2" Finishing Nails** into Rear Rear Top Plate.

<u>Parts</u> Rear Filler Strip (5/8" x 1 1/2" x 69 1/2")	<u>Hardware</u> 1 1/2" Finishing Nails x 6 total
---	---

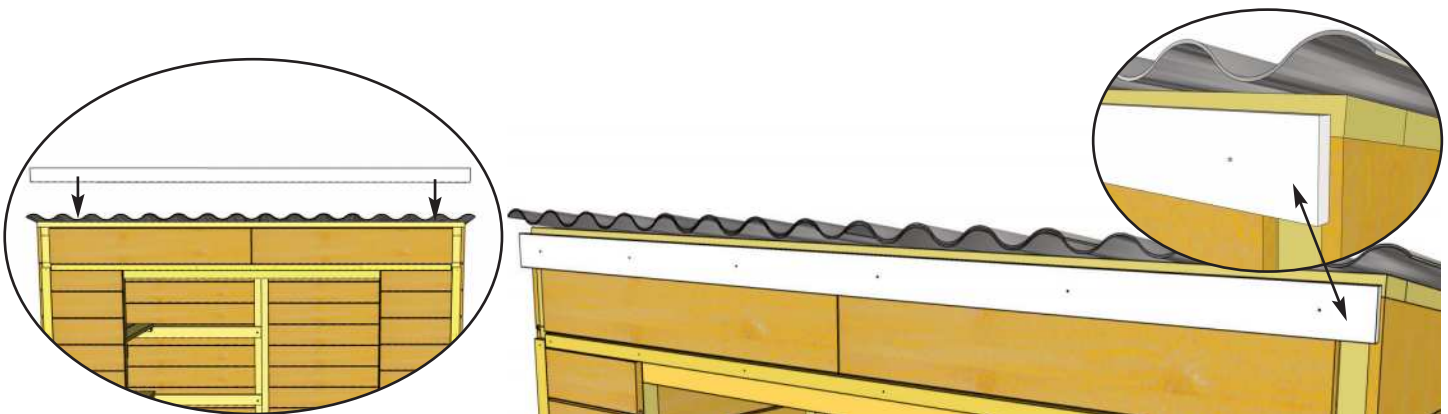

41. Locate **Upper Front Horizontal Trim** and position underneath Roof Panel. Evenly space from side to side. Secure with **6 - 1 1/2" Finishing Nails** into Wall Extenders.

<u>Parts</u> Upper Front Horizontal Trim (1/2" x 2 1/2" x 74 1/4")	<u>Hardware</u> 1 1/2" Finishing Nails x 6 total
---	---

Expert Advice:
Do a dry run with Front and Rear Corner Trims before attaching. Confirm the rough face is configured correctly and small trim gaps are satisfactory before attaching.

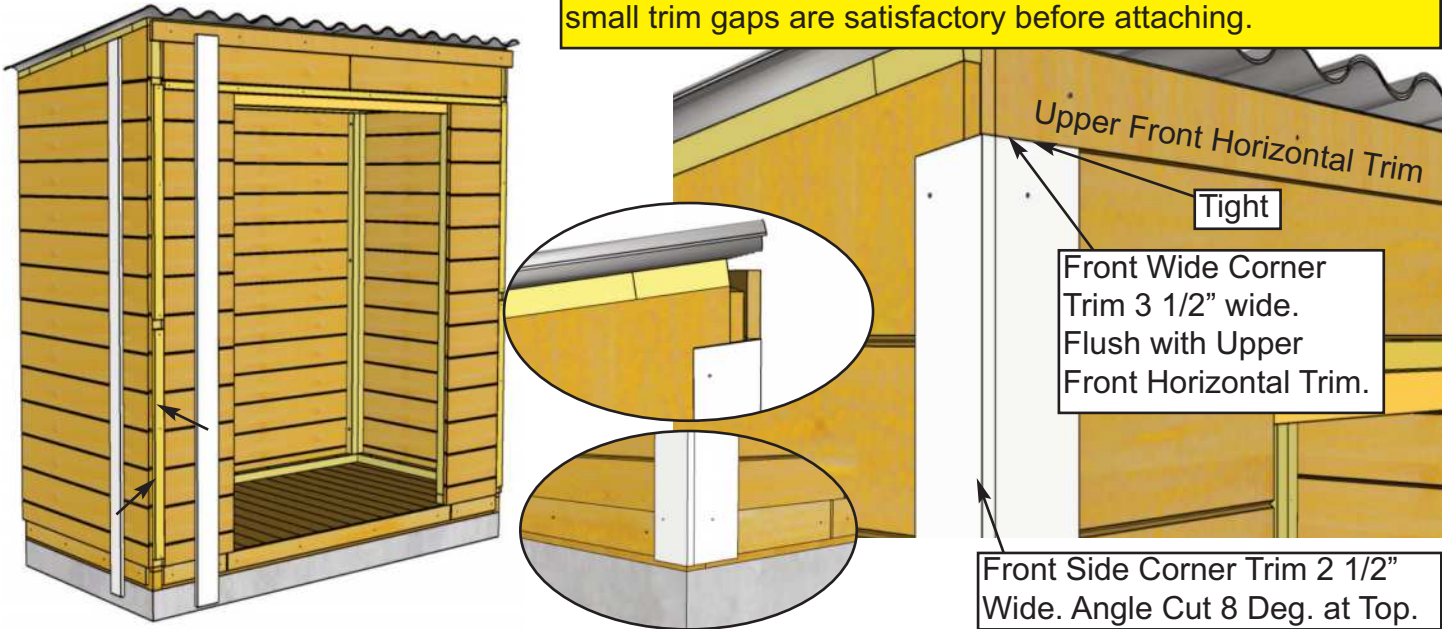

42. Locate a **Front Wide Corner Trim** and **Front Side Corner Trim**. Angled Side Trim pieces are unique to each corner and are attached **rough side out**. Starting in one corner, position both Trims up tight underneath Upper Front Horizontal Trim. Align Front Wide Corner Trim flush against Upper Front Horizontal Trim. Front Side Corner Trim will cap Front Wide Corner Trim. When correctly aligned, attach each piece with **6 - 1 1/2" Finishing Nails**.

<p><u>Parts</u></p> <p>Front Wide Corner Trim (1/2" x 3 1/2" x 70 3/8")</p> <p>Front Side Corner Trim (Angle Cut At Top) (1/2" x 2 1/2" x 70 3/8")</p>	<p><u>Hardware</u></p> <p>1 1/2" Finishing Nails x 12 total</p>
--	--

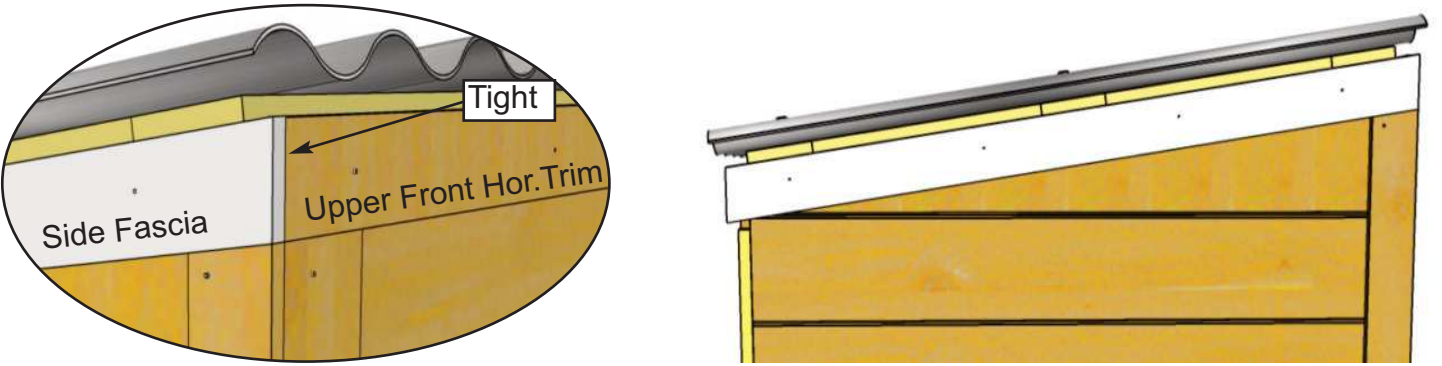

43. Continuing around the shed, place a **Side Fascia Trim** tight against Upper Front Horizontal Trim and underneath Metal Roof. Align Side Fascia with Side Corner Trim. Attach Side Fascia Trim to Side Angle Gable with **4 - 1 1/2" Finishing Nails**.

<p><u>Parts</u></p> <p>Side Fascia Trim (Angle Cut Both Ends) (1/2" x 2 1/2" x 37 5/8")</p>	<p><u>Hardware</u></p> <p>1 1/2" Finishing Nails x 4 total</p>
--	---

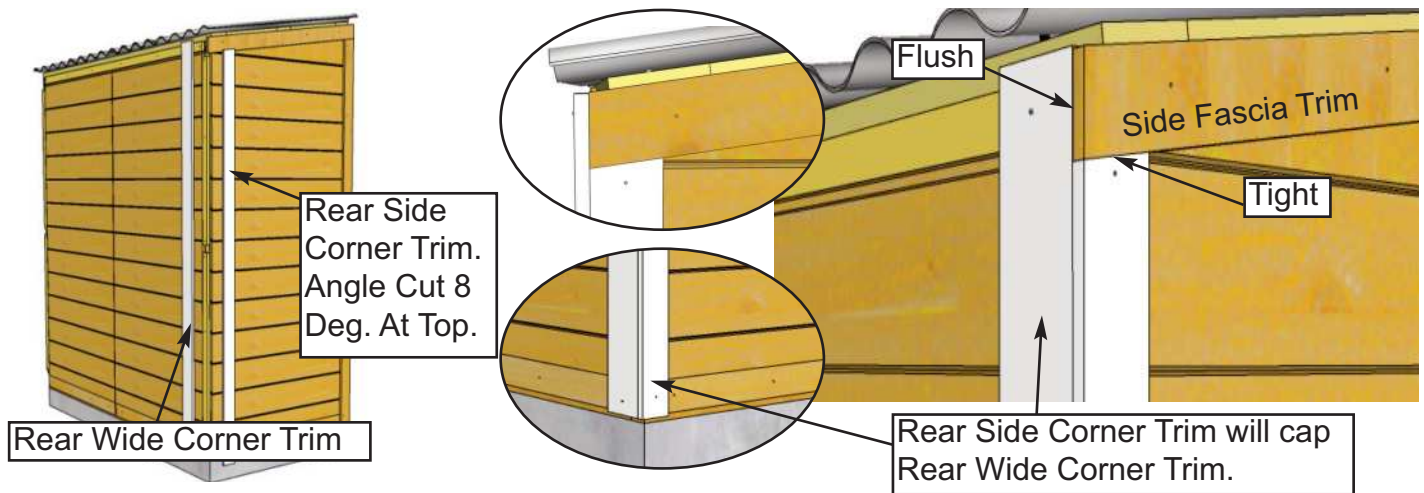

44. Locate a **Rear Side Corner Trim** and **Rear Wide Corner Trim**. Once again, angled Side Trim pieces are unique to each corner and are attached **rough side out**. Position Rear Side Trim tight underneath Side Fascia Trim. Align Rear Wide Corner Trim underneath Metal Roof and flush with Side Fascia Trim. Rear Side Corner Trim will cap Rear Wide Corner Trim. Attach each piece with **6 - 1 1/2" Finishing Nails**.

Parts	Hardware
Rear Wide Corner Trim (1/2" x 3 1/2" x 67 3/4") Rear Side Corner Trim (Angle Cut At Top) (1/2" x 2 1/2" x 65 1/2")	1 1/2" Finishing Nails x 12 total



45. Locate **Upper Rear Horizontal Trim** and align tight against Rear Wide Corner Trim and underneath Metal Roof. Attach to Rear Filler Strip with **6 - 1 1/2" Finishing Nails**.

Parts	Hardware
Upper Rear Horizontal Trim (1/2" x 2 1/2" x 67 1/4")	1 1/2" Finishing Nails x 6 total

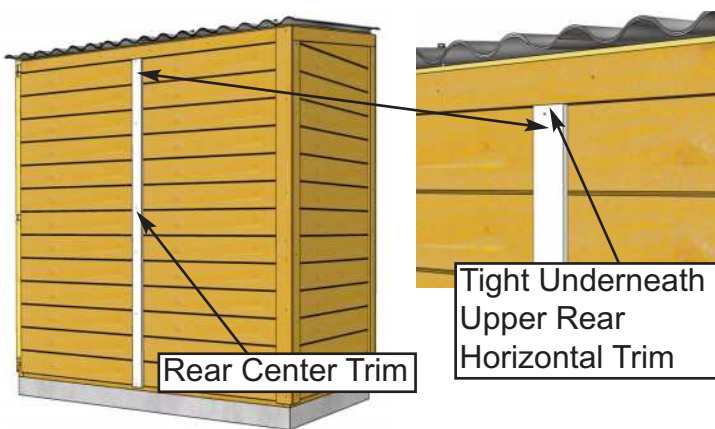

46. Locate **Rear Center Trim**. Align tight against Upper Rear Horizontal Trim and attach with **6 - 1 1/2" Finishing Nails**.

Parts
Rear Center Trim (1/2" x 2 1/2" x 65 1/8")
Hardware
1 1/2" Finishing Nails x 6 total



47. Complete other Rear Corner, Side Fascia and Front Corner Trims as per **Steps 42 - 44.**

Parts

Rear Wide Corner Trim

(1/2" x 3 1/2" x 67 3/4")

Rear Side Corner Trim (Angle Cut At Top)

(1/2" x 2 1/2" x 65 1/2")

Side Fascia Trim (Angle Cut Both Ends)

(1/2" x 2 1/2" x 37 5/8")

Front Wide Corner Trim

(1/2" x 3 1/2" x 70 3/8")

Front Side Corner Trim (Angle Cut At Top)

(1/2" x 2 1/2" x 70 3/8")

Hardware

1 1/2" Finishing Nails

x 28 total

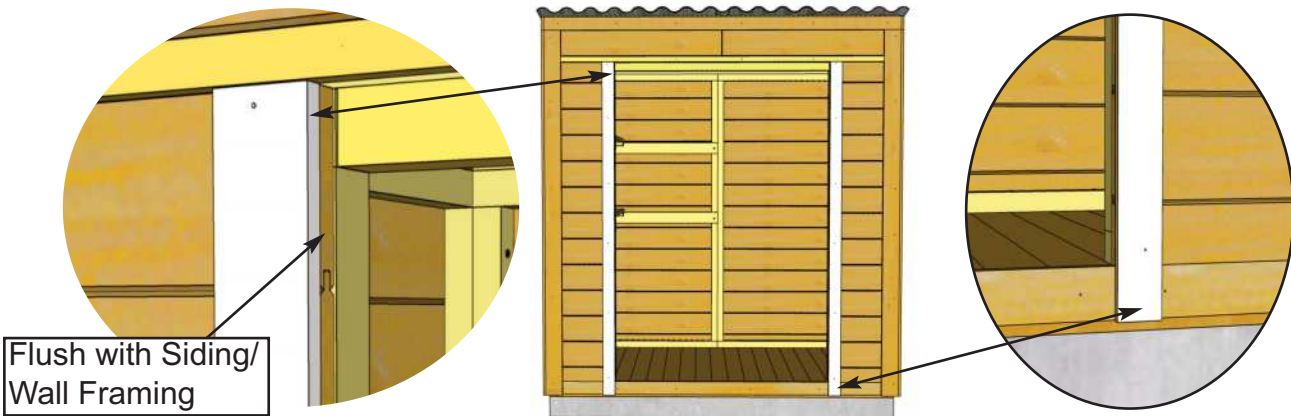

Flush with Siding/
Wall Framing

48. Locate 2 **Vertical Door Frame Trims**. Position on Front Narrow Wall flush with Wall siding/ framing and underneath Front Header Filler Strip. Attach with **6 - 1 1/2" Finishing Nails**.

Parts

Vertical Door Frame Trims

(1/2" x 2 1/2" x 64 1/4") x 2

Hardware

1 1/2" Finishing Nails

x 12 total

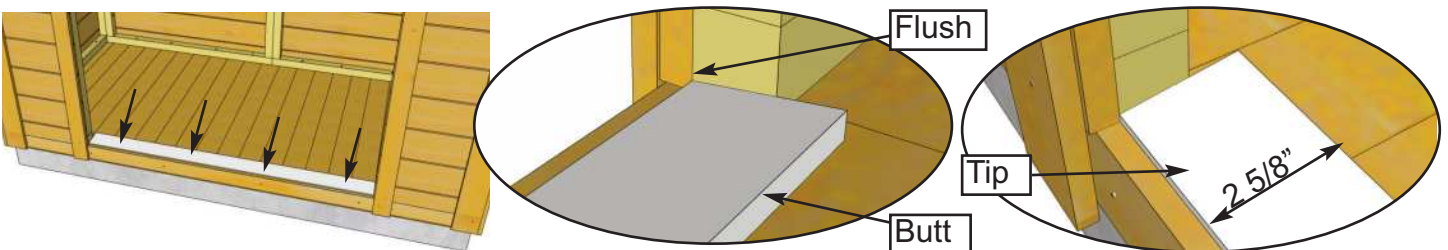

49. Locate **Door Threshold (Bevel)** and position on Floor at the opening. Align tip of the bevel flush with the outside of the Bottom Wall Plate. Attach with **4 - 1 1/4" Brown Screws**.

Parts

Door Threshold (Bevel)

(1/2" x 2 5/8" x 44 7/8")

Hardware

1 1/4" Brown Screws

x 4 total

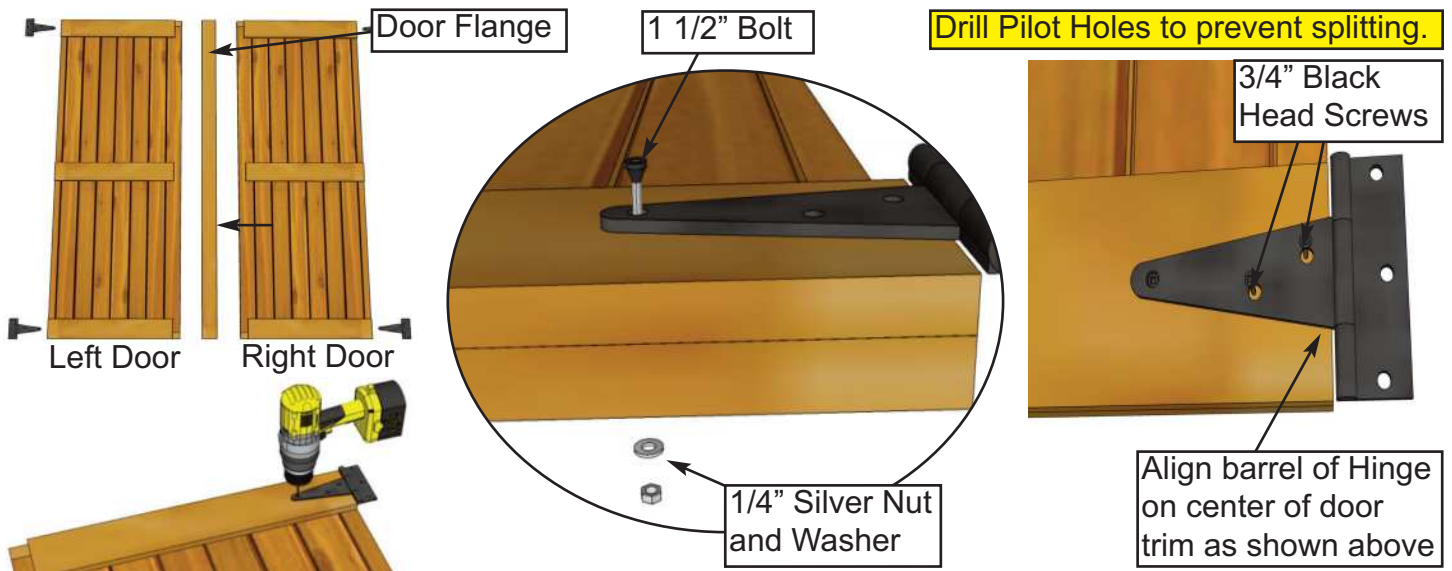

50. Locate **Left and Right Doors** and **Door Flange**. Orientate Doors so the outside of each Door is facing up. Locate **Black T Hinges**. Prior to attaching, position Hinges equally on Door trim as shown above and with a 1/8" drill bit, drill a hole through the tip of the Hinge and all the way through the Door. Complete for all 4 hinges. Attach each Hinge to Door as above with **1 - 1 1/2" Black Headed Bolt**, and a **1/4" Silver Nut and Washer**, using a 3/8" wrench. Finish Hinge by securing with **2 - 3/4" Black Headed Screws**. Drill small pilot holes first to prevent wood from splitting. Complete both Doors (4 Hinges).

Parts (Step 50 - 54)
Left and Right Doors
 (22 1/4" x 61 3/8")
Door Flange
 (1/2" x 2 1/2" x 61 3/8")

Hardware (Step 50 - 54)
Black T Hinge x 4 total
1 1/2" Black Headed Bolt x 4 total
1/4" Silver Nut and Washer x 4 total
3/4" Black Headed Screws x 8 total
1" Silver Screws x 6 total
2" Black Headed Screws x 12 total

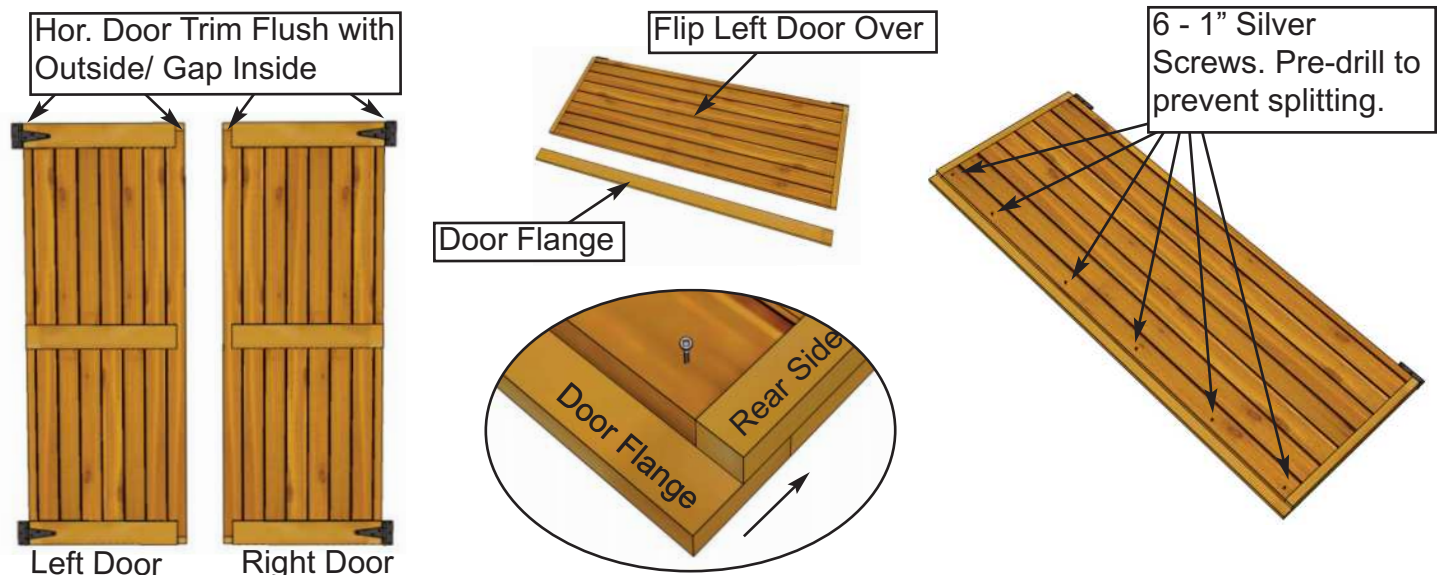

51. Flip Left Door over to attach **Door Flange**. Position Door Flange tight against horizontal trim and even with trim on top and bottom. If out slightly, make sure top horizontal trim and Flange are even. Pre-drill with 1/8" bit to prevent wood from splitting. Attach with **6 - 1" Silver Screws**.

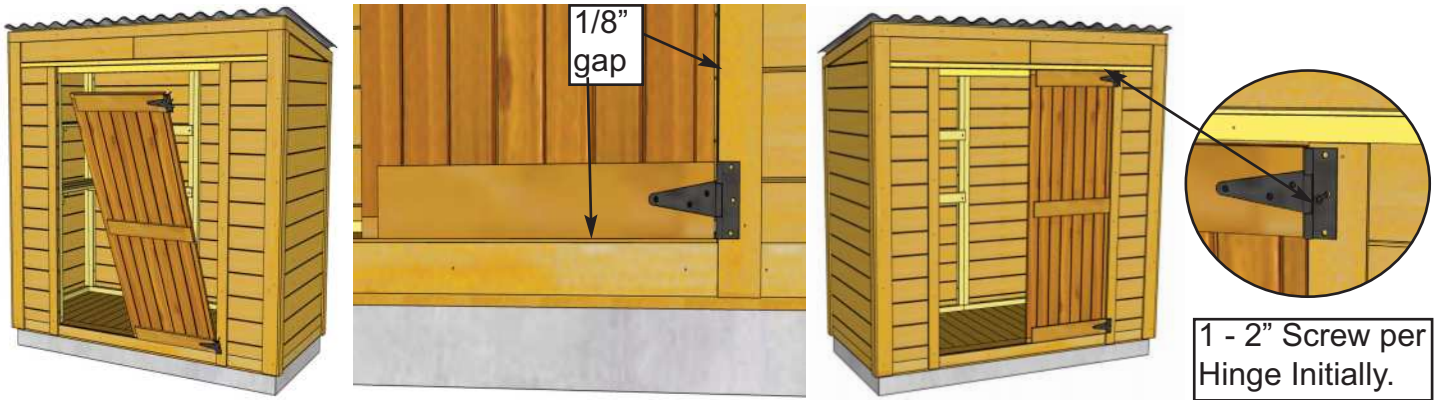

52. Starting with Right Door first, lift and position Door in opening. Leave a 1/8" gap on right side and 1/8" gap on the bottom. Use a **Cedar Shingle Shim** to shim the Door at bottom to help position door evenly. When Door is aligned correctly, screw hinge into Vertical Door Frame Trim with **1 - 2" Black Headed Screws**. Use only 1 screw initially per Hinge until both Door alignments are confirmed. Drill pilot holes to prevent wood from splitting.



53. Position Left Side Door (with Flange) as per **Step 52**. Once again, use only **1 - 2" Black Headed Screw** per Hinge initially to secure door to Vertical Door Frame Trim.

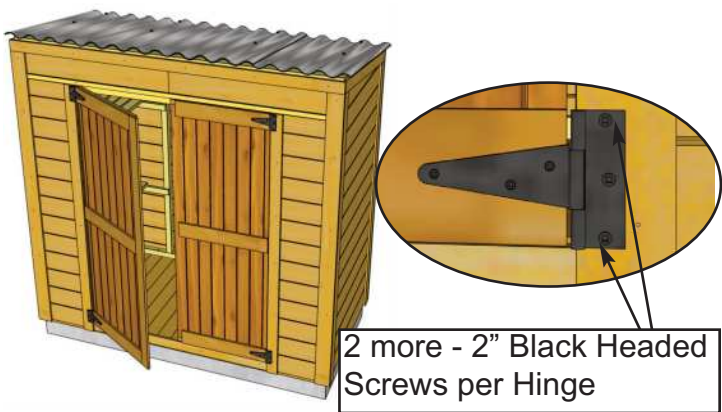

54. With both Doors partially attached, check to see Doors open and close correctly. Make any necessary adjustments and when satisfied, completely secure Hinges to Vertical Door Frame Trim with **two more 2" Black Headed Screws** per Hinge. Drill pilot holes to prevent wood from splitting.



55. Attach **Door Handles** to Doors with **4 - 3/4" Black Headed Screws** per Handle. Choose desired Handle height.

- Hardware
Black Handle x 2 total
3/4" Black Headed Screws x 8 total

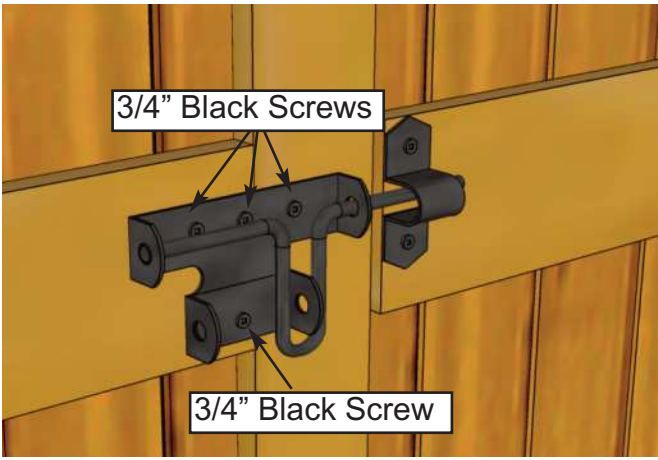

Important: Drill shallow Pilot Holes to prevent splitting.

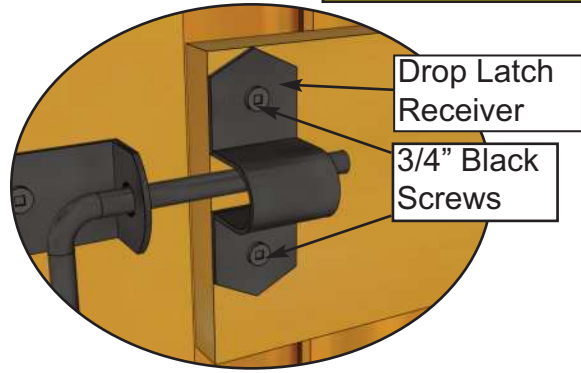

56. Attach **Black Drop Latch** as illustrated above with **6 - 3/4" Black Headed Screws**.
Note: Black Drop Latch receiver is positioned higher than male. Do a dry run first to position Black Drop Latch correctly. **Important** - Drill pilot holes with 1/8" drill bit prior to securing with screws to prevent wood splitting.

Hardware
Black Drop Latch
3/4" Black Headed Screw x 6 total

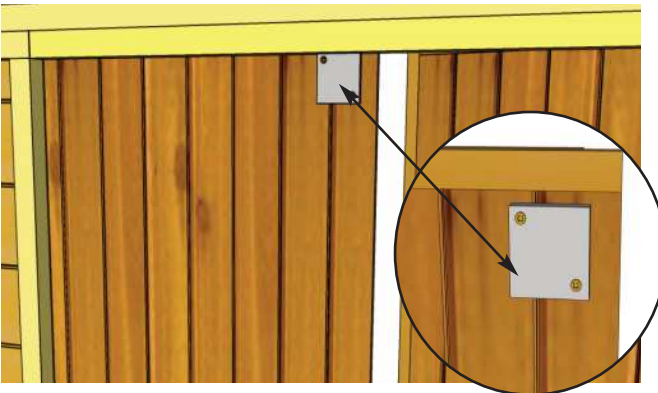

57. Install the **Plywood Spacer** to interior door frame approximately 1 1/2" from top of door frame and 1" from edge, as pictured. Use **2 - 1 1/4" Brown Screws** to secure. Plywood Spacer should fit flush underneath Interior Door Header when Door is closed.

Hardware
Plywood Spacer (1/2" x 2 1/2" x 2 1/2")
1 1/4" Brown Screws x 2 total

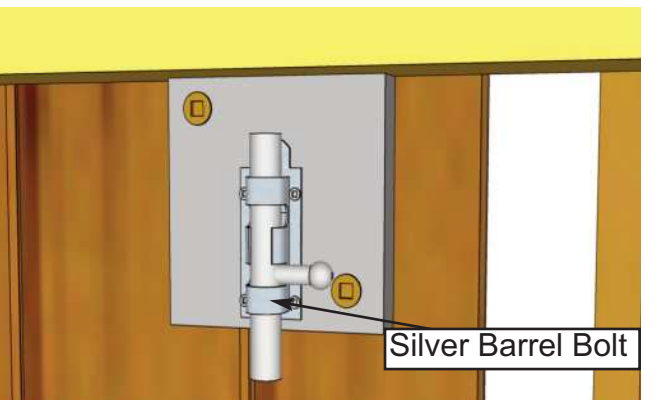

58. Position the **Interior Silver Barrel Bolt** on the Plywood Spacer and attach with **4 - 3/4" Silver Screws**. Tap Silver Barrel Bolt with hammer on underside of Interior Door Header to mark location.

Hardware
Interior Silver Barrel Bolt
3/4" Silver Screws x 4 total

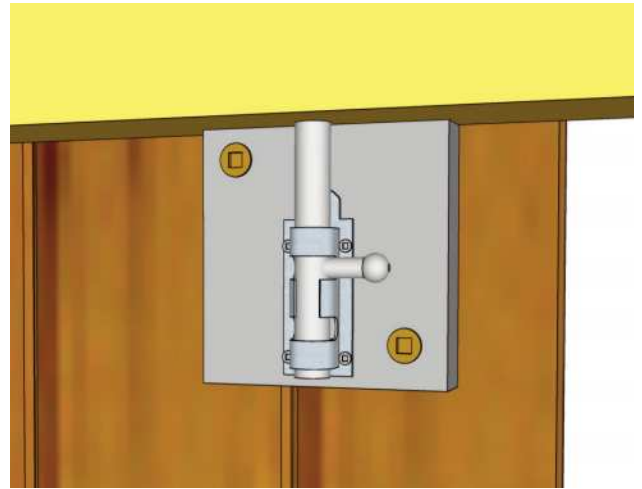

59. Open Door and drill out marked Silver Barrel Bolt impression with a 3/8" Drill Bit. Close Door, slide Interior Silver Barrel Bolt in drilled hole to confirm fit.

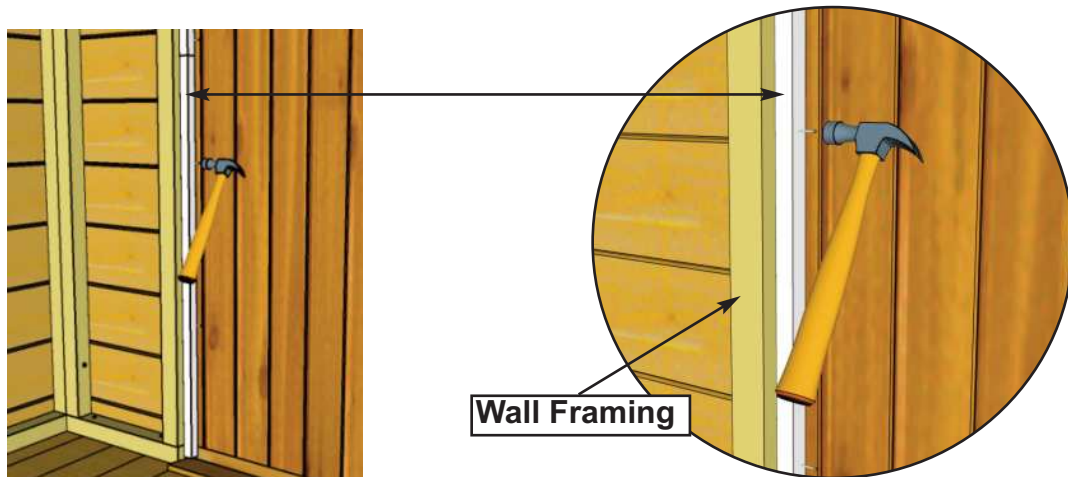

60. Attach **Interior Vertical Door Stops** to inside Wall framing with **4 - 1 1/2" Finishing Nails** per piece. To align correctly, close Door to make sure Stops are close to the Door but don't interfere with their closing. Attach bottom piece first with hammer.

<p><u>Parts (Step 60 - 61)</u> Interior Vertical Door Stops (3/4" x 3/4" x 29 7/8") x 4</p>	<p><u>Hardware (Step 60 - 61)</u> 1 1/2" Finishing Nails x 16 total</p>
--	--

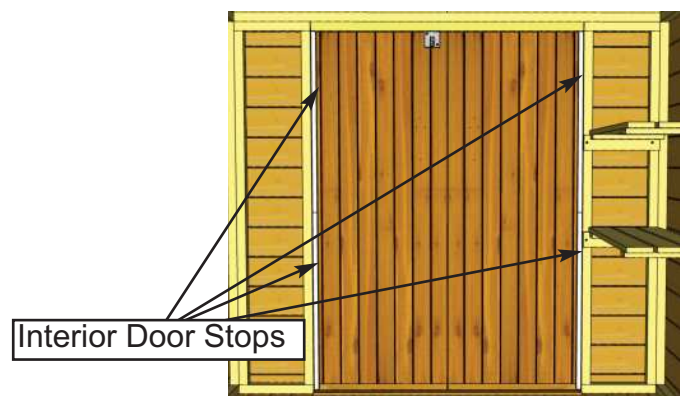

61. Attach top Interior Door Stop as per **Step 60** and then complete the opposite side.



62. Locate **Front Horizontal Trim** and **Metal Drip Edge**. Position Metal Drip Edge behind Door Trim. Evenly space from side to side. While holding down both Metal Drip Edge and Front Horizontal Trim, secure with **6 - 1 1/2" Finishing Nails** into Front Header Filler Strip.

<u>Parts</u> Front Horizontal Trim (1/2" x 3" x 67 1/4") Metal Drip Edge (60")	<u>Hardware</u> 1 1/2" Finishing Nails x 6 total
---	---



63. Locate **Front Middle Trim** and position tight against Horizontal Above Door Trim and Upper Front Horizontal Trim. Attach with **2 - 1 1/2" Finishing Nails**.

<u>Parts</u> Front Middle Trim (1/2" x 2 1/2" x 2 5/8")	<u>Hardware</u> 1 1/2" Finishing Nails x 2 total
--	---



64. Locate **Foam Enclosures** and place 3 pieces on top of Metal Roof at the front, to go underneath the **Metal Peak Caps**. Place Metal Peak Caps on top of Foam Enclosures and evenly space from side-to-side, allowing the Peak Caps to overlap each other. Overhang each cap approximately 1" on each end. When Peak Caps are correctly positioned, secure with **4 - 2" Metal Screws**, using 1/4" Nut Driver as per **Step 32**. Screw into top most Batten. Metal screws are self-tapping, do not overtighten!

<u>Parts</u> Metal Peak Caps x 2 (60") Foam Enclosures x 3	<u>Hardware</u> 2" Metal Screws x 4 total
--	--

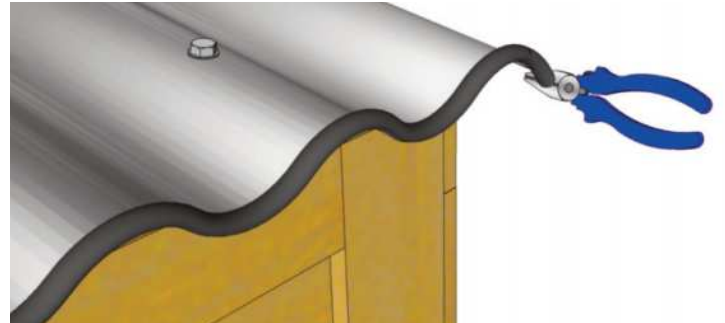
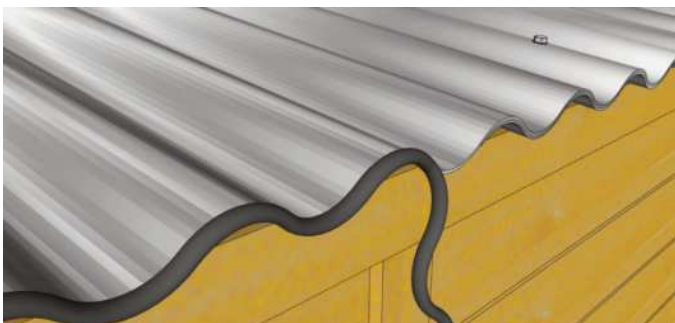

65. Locate **Metal Roof Edge Trim** and fit along the lower edge of the Metal Roof. When the edging is in place, use pliers to cut the end to the desired length.

<u>Parts</u> Metal Roof Edge Trim (96")



Note: Our Sheds are shipped as an unfinished product. If exposed to the elements, the lumber will weather to a silvery-gray color. If you prefer to keep the lumber looking closer to the original color, we suggest that you treat the wood with a good oil base wood stain. You may also wish to paint your new shed rather than stain it. In both cases we recommend that you consult with a paint and stain dealer in your area for their recommendations.

Congratulations on assembling your 6x3 Garden Saver!

We hope your experience constructing our **6x3 Garden Saver** has been both positive and rewarding. We value your feedback and would like to hear back from you on how well we are doing in the following areas:

1. **Customer Service**
2. **On Time Shipping**
3. **Motor Freight Delivery**
4. **Quality of Materials**
5. **Assembly Manual**
6. **Overall Satisfaction**



The materials contained in this Assembly Manual may be downloaded or copied provided that ALL copies retain the copyright and any other proprietary notices contained on the materials. No material may be modified, edited or taken out of context such that its use creates a false or misleading statement or impression as to the positions, statements or actions.

Please call, write or email us at:

Canadian Address
9393 287th Street
Maple Ridge, British Columbia
Canada V2W 1L1

United States Address
P.O. Box 96
Sumas, Washington
USA 98295

Toll Line: 1.888.658.1658 | **Fax: 1.604.462.5333** | **sales@outdoorlivingtoday.com**